



EDINBURGH  
INSTRUMENTS

# SPECTROFLUOROMETER

## FS5



# FS5 SPECTROFLUOROMETER



## CONTENTS

### 2

#### OVERVIEW AND SOFTWARE

Single photon counting sensitivity, optical design, reliability and unrivalled Fluoracle® software.

---

### 6

#### MEASUREMENT EXAMPLES

Various types of measurements, scans and sample types.

---

### 8

#### UPGRADE OPTIONS

Routes to upgrade and enhance the capabilities of the core FS5 Spectrofluorometer.

---

### 10

#### SAMPLE MODULES AND ACCESSORIES

Intelligent 'Plug and Play' sample modules and accessories to handle all types of sample materials.

The FS5 is a fully integrated, purpose-built spectrofluorometer. Suited for analytical and research laboratories, the FS5 can handle the speed of routine analysis and the sensitivity of demanding research requirements.

Comprehensive Fluoracle® software allows for astonishing ease of use and the design concept enables maximum flexibility, with multiple measurement modes all in one instrument:

- > Steady State Fluorescence
- > Fluorescence Lifetime (TCSPC)
- > Phosphorescence Lifetime (MCS)
- > Spectral Coverage into the Near-Infrared
- > Polarisation and Anisotropy (POL)

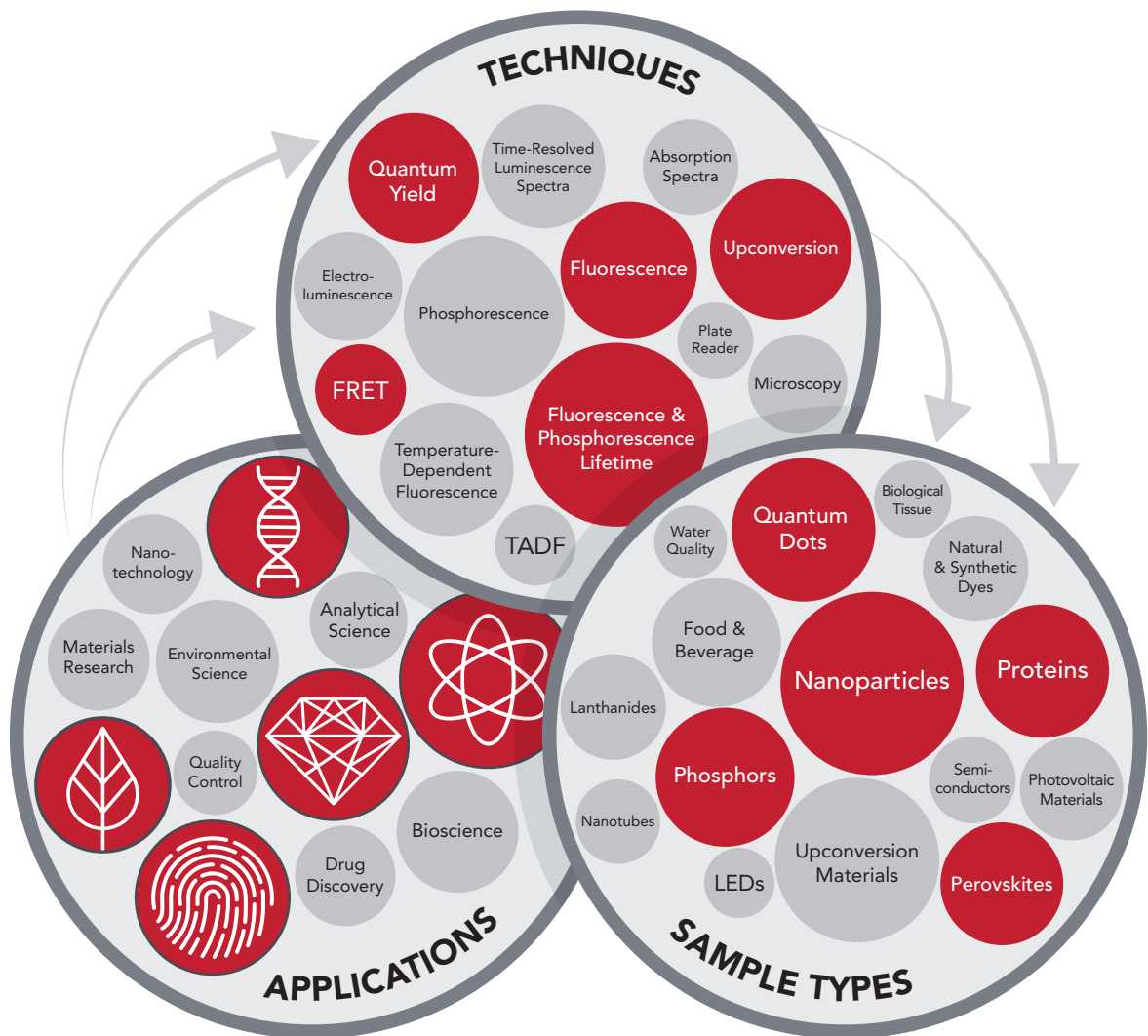
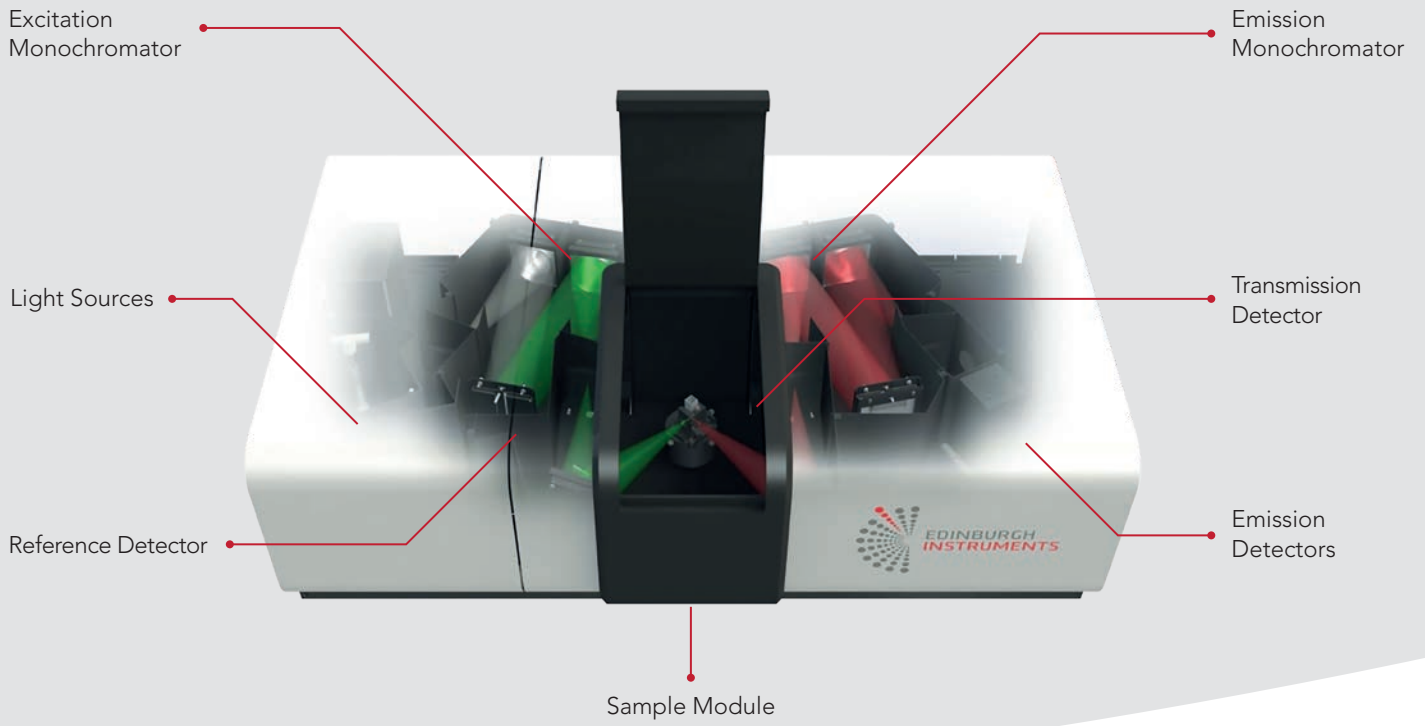

## INSTRUMENT SENSITIVITY

To achieve optimal sensitivity, resolution, and acquisition speed, we engineer the FS5 with an air-sealed excitation path to enhance the excitation power in the UV, select only the optimal performance photomultipliers in temperature stabilised housings, utilise an optical design that includes plane, spherical, toroidal, ellipsoidal mirrors and optimised mirror coatings. The FS5 is truly unrivalled in its spectral performance and sensitivity.

Not only does this superior design guarantee the highest sensitivity and broadest wavelength coverage, it has also been optimised for a small bright focus at the sample position. This is important for measuring small sample volumes and benefits many sample holder attachments such as the plate reader, fibre launch optics, titrators and sample positioners.

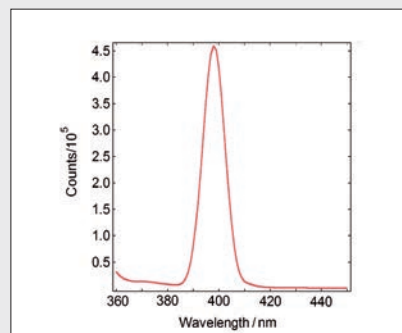

Sensitivity is generally specified by the Raman spectrum of water, excited at 350 nm, spectral bandwidths of 5 nm in excitation and emission, integration time of 1 s.

The FS5 guarantees a signal-to-noise ratio of >6000:1 for these measurement conditions, calculated from the signals taken at the peak at 397 nm (b) and the background at 450 nm (a) using:  $SNR_{SQRT} = (b-a)/SQRT(a)$ .

## PHOTON COUNTING

Single Photon Counting is light detection at the quantum limit. This detection method is intrinsically digital and therefore less susceptible to noise interference than other methods. As a true counting technique, each measured count value (photon) comes with known statistical accuracy.

Single Photon Counting is used for all measurement modes; not only for standard spectral scanning and kinetic measurements, but also for the optional fluorescence and phosphorescence lifetime measurements.

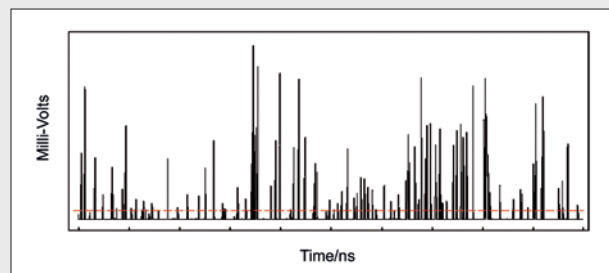

Typical pulses from a single photon counting photomultiplier. Only photon pulses above a certain threshold value are counted. This eliminates unstable background and associated noise.

## OPTICAL DESIGN, RELIABILITY AND ACCURACY

The FS5 has an optical design that is superior to all known instruments of this class, utilising optical components that are specially selected to optimise performance.

The embedded monochromators are the largest in their class with a 225 mm focal length. This ensures better imaging quality and higher optical throughput, increasing resolution and enhancing sensitivity. The FS5 uses minimal optical reflections and all optical coatings provide the highest degree of reflectivity and lowest scatter.

Spectral calibration is used to ensure wavelength accuracy and repeatability and photometric calibration is used to ensure presentation of true spectra without distortion of instrumental throughput functions.

Traceable standards from NIST and BAM are used throughout the full wavelength coverage to verify calibration. This gives the user complete confidence in the data that the FS5 delivers.

**Below:** NIST standards (left) and BAM standards (right), as measured with the FS5 under recommended measurement conditions.

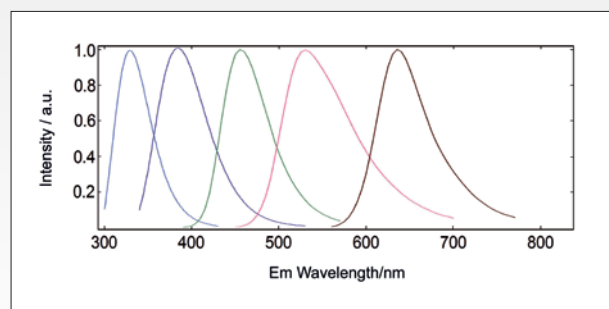
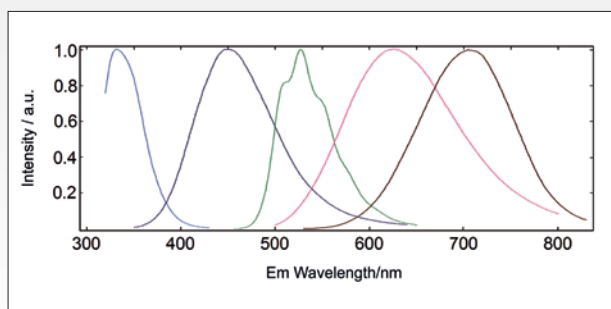

## FLUORACLE® SOFTWARE

The operating software for the FS5 Spectrofluorometer is named Fluoracle. This is an exceptional software package specifically written for instrument control and data handling. Fluoracle controls all FS5 steady state and time-resolved features with a straightforward design concept. It focuses on all modern photoluminescence spectroscopy applications, while at the same time provides a user-friendly interface with 'ready to publish' outputs.

Whether you select a basic spectral scanning version of the FS5 or a version that includes advanced accessories, the software will provide all instrument options, from data acquisition, to analysis and finally presentation.

Fluoracle enables live signal monitoring and parameter optimisation before every measurement. The instrument status and signal are displayed and constantly updated during measurements. All modes of data acquisition, as well as third-party accessories such as cryostats, are controlled from Fluoracle.

**Below:** Fluoracle software interface with live signal rate display.

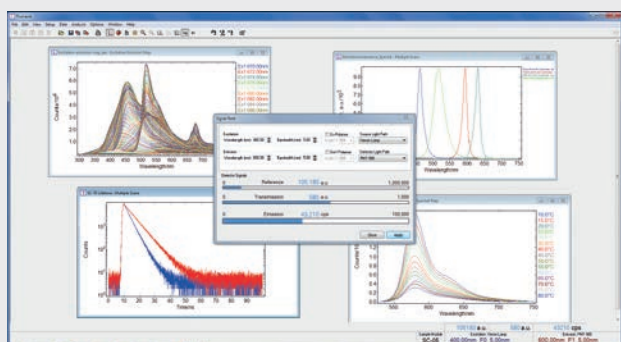

Batch acquisition is available in Fluoracle. The user can program a sequence of measurements including delays, loops, temperature or sample changes (accessory dependent). Batch files can be saved and loaded when needed.

**Below:** Batch measurement setup.

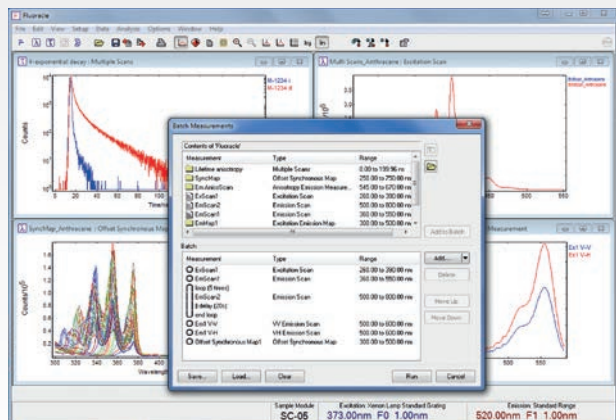

Analysis methods such as photoluminescence quantum yield, chromaticity coordinates, absorption, or anisotropy are implemented in user-friendly wizards. Analysis of time-resolved photoluminescence is straightforward in Fluoracle: up to 4 exponential components can be fitted to fluorescence or phosphorescence decays instantly. Reconvolution fitting, shift and offset fitting, and fit quality parameters are provided as standard.

**Below:** Quantum Yield measurement wizard.

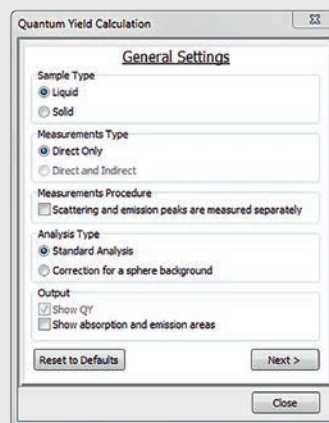

## ✓ FEATURES AVAILABLE AS STANDARD

- Live Signal Monitoring
- Load / Save Measurement Settings
- Batch Measurements
- Correction and Higher Order Removal
- Plug-and-play Sample Holders / Accessories
- Excitation, Emission, Synchronous Spectra
- Spectral Maps
- Absorption / Transmission / Fluorescence
- Kinetic Scans
- Service Scans
- Chromaticity Analysis

## ↑ FEATURES INCLUDED WITH UPGRADES

- Fluorescence Lifetime (TCSPC)
- Phosphorescence Lifetime (MCS)
- Quantum Yield Analysis
- Temperature Scans / Maps
- Spectral and Time-Resolved Anisotropy
- Virtual (software) Gating
- Near-Infrared Measurements
- Plate Reader / Multiple Sample Measurements

## EXCITATION AND EMISSION SCANS

In spectral scans, fluorescence intensity is recorded as a function of excitation or emission wavelength. The data is automatically corrected for the spectral response of the instrument and variations in excitation power thanks to its accurate, factory generated correction files and silicon reference detector.

The FS5 delivers fully corrected, reliable data without any post-processing steps.

**Right:** Anthracene in cyclohexane, excitation (blue) and emission (red) spectra.

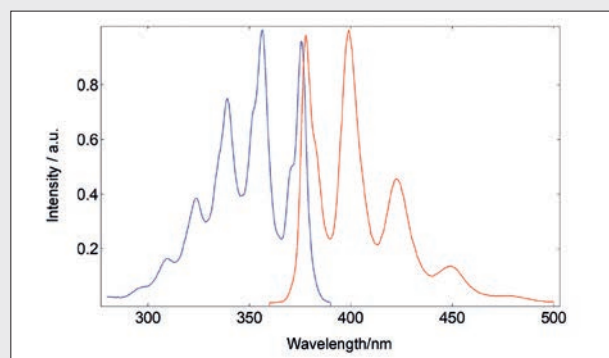

## SYNCHRONOUS SCANS

In synchronous spectral scans, the excitation and emission monochromators scan at the same time with a fixed wavelength offset. For dilute mixtures this type of scan is used to identify species with a strong overlap between absorption and emission.

Synchronous scans, together with the integrating sphere sample module, can also be used to measure the absorption spectra of strongly scattering powders.

**Below:** YAG:Ce powder, diluted with BaSO<sub>4</sub>, to study the effect of re-absorption/emission, concentration change from 100% down to 20%. The software wizard is used to calculate the absorbance (left) from the raw data of synchronous scans (right).

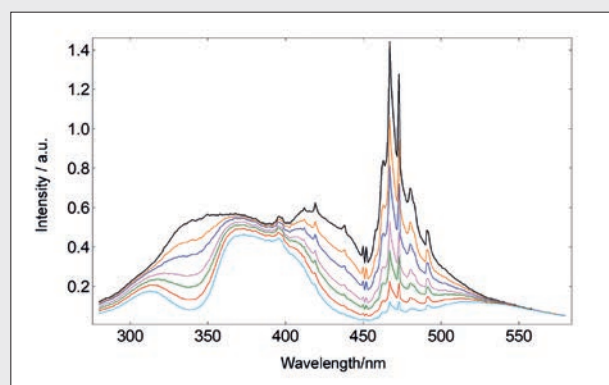
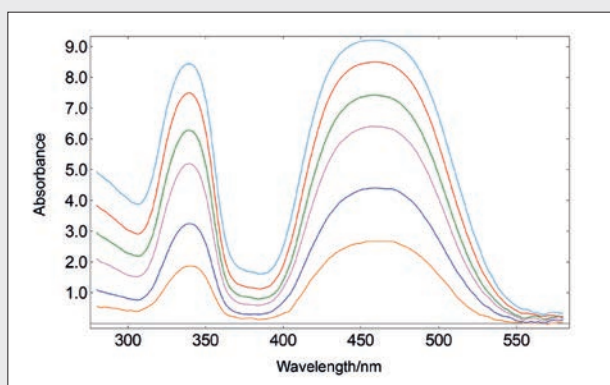

## KINETIC SCANS - STOP FLOW

The FS5 can record the time course of the fluorescence and absorption of a sample simultaneously using a kinetic scan. The kinetic scan is useful for measuring slow changes in absorption and fluorescence (milliseconds to hours) and is particularly suited to monitor the progress

of chemical reactions after mixing two reactants together with the titrator or stopped-flow accessory. Information from the kinetic scan can be then used to calculate the order and rate constants of the reaction.

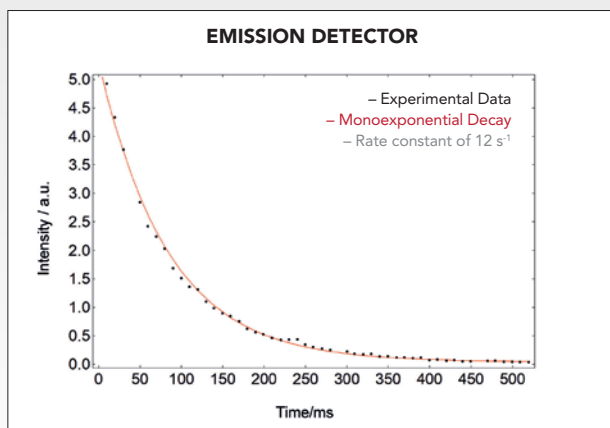

Fluorescence quenching of NATA by NBS using the stopped-flow accessory. The fluorescence kinetic of NATA quenching was recorded using the emission detector of the FS5.

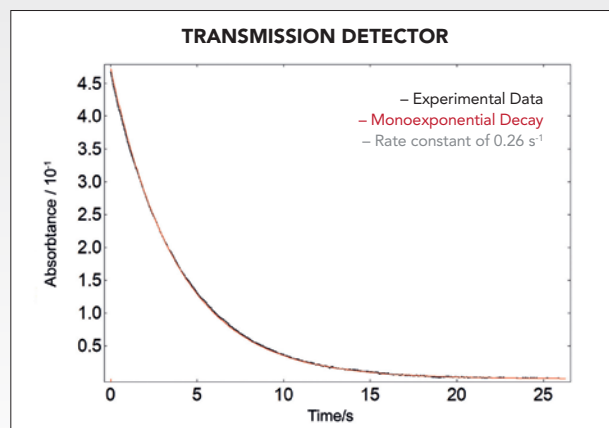

Bleaching of K<sub>4</sub>[Fe(CN)<sub>6</sub>] by Ascorbic Acid using the stopped-flow accessory. The absorption kinetic of Fe(CN)<sub>6</sub><sup>3-</sup> bleaching was recorded using the transmission detector of the FS5.



## ABSORPTION / TRANSMISSION SCANS

The FS5 is equipped with a transmission detector as standard which enables the absorption and fluorescence spectra of a sample to be measured using a single instrument.

The transmission detector can also be used to monitor the change in transmission through a sample during a fluorescence measurement and correct for any changes in absorbance that occur; which is particularly useful for unstable biological and photosensitive systems.

**Right:** Absorption and emission spectra of a perovskite quantum dot in cyclohexane. It reveals that the fluorescence emission occurs at the band edge of the quantum dot as the emission peak is coincident with the sharp drop in the absorbance that marks the band edge.

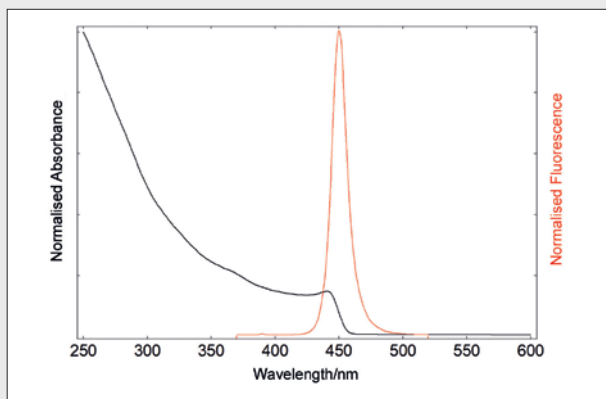

## ABSOLUTE FLUORESCENCE QUANTUM YIELD

Fluorescence quantum yields (QY) of liquids, powders and thin-films can be measured by using the integrating sphere module. The module comprises of a hollow sphere of 150 mm diameter with the inner surface machined from a PTFE-based material for optimum reflectance.

Various sample holders can be housed in the integrating sphere including standard and reduced optical path cuvettes for liquids, to sample dishes with quartz caps for powders.

Samples can be measured with direct and indirect illumination and QY calculations can be made using the QY wizard within the Fluoracle software for complete ease of use.

**Right:** Cerium-doped Yttrium Aluminium garnet powder. The scan over the excitation scatter at 430 nm and the emission of the sample (blue), and the scatter of the blank measurement (red). **Inset:** The setup dialogue and the results window of the QY wizard in Fluoracle.

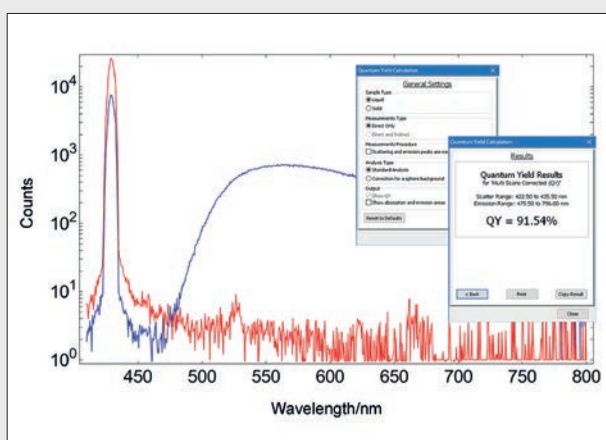

## CHROMATICITY AND COLOUR COORDINATES

The lighting industry requires precise determination of the colour coordinates of fluorescent powders and light emitting diodes. The FS5 provides chromaticity analysis tools for the determination of colour coordinates using CIE 1931 and CIE 1976.

**Below:** Emission spectra of four commercial Indium Gallium Nitride (InGaN) LEDs with blue, green, yellow and red emission.

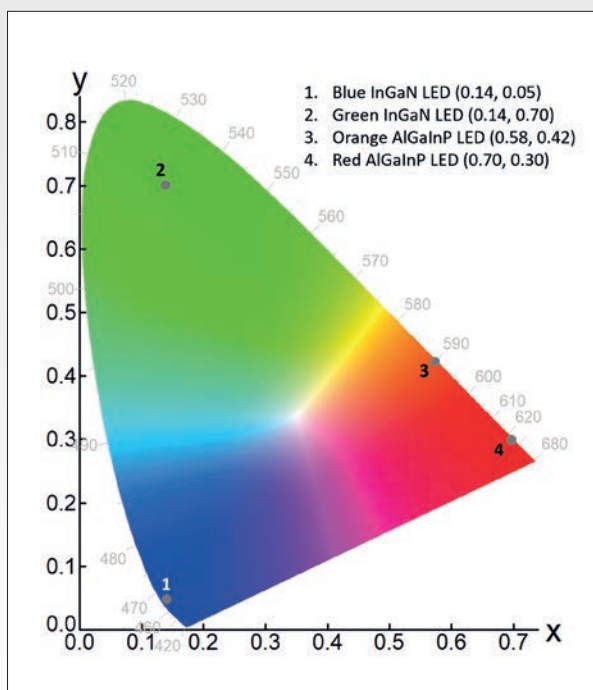
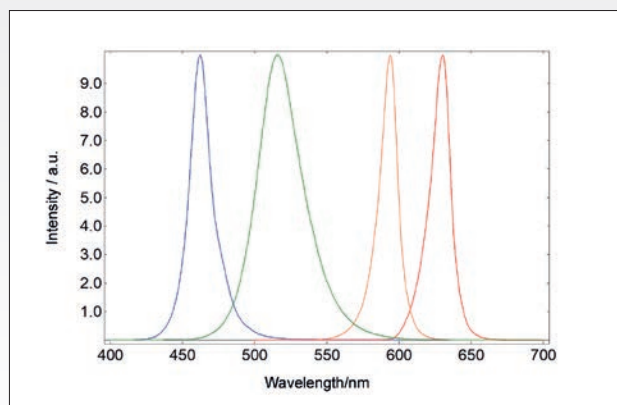

## EXCITATION-EMISSION MAPS

Excitation-Emission Maps (EEMs) provide a 'fingerprint' of complex mixtures of substances. These maps can be measured either by a series of emission scans with a stepwise increase or decrease of the excitation wavelength or by a series of synchronous scans and stepwise increase of the excitation-emission offset.

A map measurement over a wide range of excitation and emission wavelengths, as shown here, can only be performed properly if higher order scatter is automatically removed during the measurement.

The FS5 utilises filter wheels with order sorting filters to remove higher order scattered light as standard.

**Right:** Excitation-emission map of Chinese Green Tea (Wuyi region).

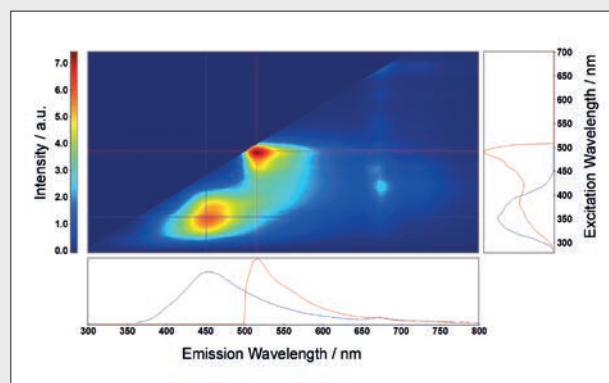

## PLATE READER

Multiple sample measurements can be made using the plate reader sample module. This can be used for liquid samples with commercial plates of up to 96 wells, but is also suitable for routine quality assessment of fluorescent powders. As with all the sample modules, this is also compatible with the FS5 upgrade options, including the lifetime upgrades.

**Right:** Quality control measurement of  $Y_2O_3Eu^{3+}$  powder samples, in a 12-well powder tray. The graph shows 12 superimposed identical measurements. The inset is an example of the measurement progress display.

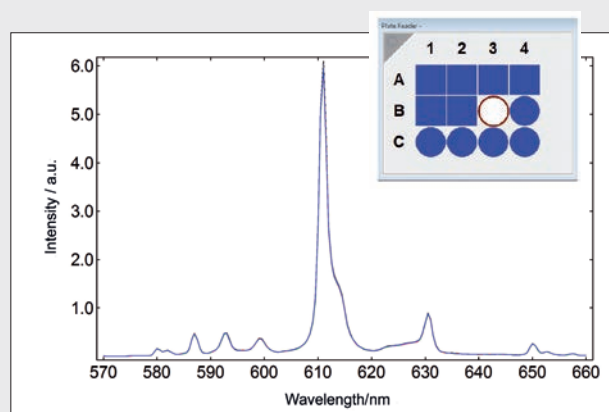

## ELECTROLUMINESCENCE

The FS5 can be equipped with a range of source meters and arbitrary function generators for electroluminescence (EL) spectroscopy, greatly expanding the capability of the instrument for device characterisation.

In EL spectroscopy a voltage is applied across a device and the properties of the emitted light are studied in a steady state or time-resolved measurement. In steady state EL a constant voltage is applied to the device and the electroluminescence spectrum is measured; while in time-resolved EL the response of the device to short voltage pulses is studied using Multi Channel Scaling (MCS) or Time-Correlated Single Photon Counting (TCSPC) techniques.

**Top:** Electroluminescence spectrum of a  $Ir(MDQ)_2(acac)$  phosphorescent OLED at a current density of  $10 \text{ mA cm}^{-2}$ .

**Bottom:** Time-resolved EL spectrum of a white light InGaN LED. The white light emission is composed of two distinct parts that occur on different timescales. Primary emission at 450 nm due to EL from the InGaN semiconductor and longer, secondary emission above 500 nm from the phosphor coating which is pumped by the primary EL.

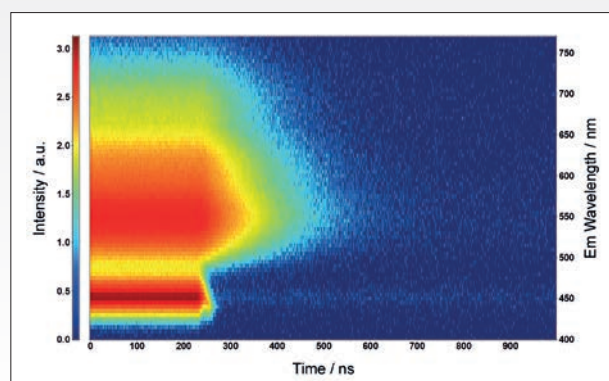
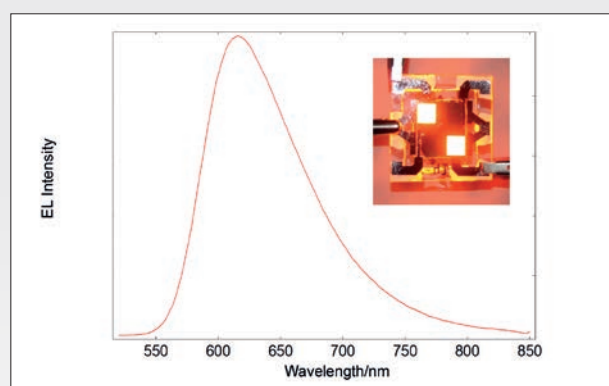



## TEMPERATURE CONTROL

There are a range of temperature control modules for the FS5, enabling the change in fluorescence and absorption of samples to be measured over a temperature range of 77K to 500K. An overview of some of the most popular modules for temperature control are highlighted below.

### Temperature Controlled Cuvette Holder - TE Cooled (-50°C to +150°C)

Temperature controlled cuvette holders for fluorescence and transmittance measurements of solutions. The temperature is fully controllable through the Fluoracle operating software of the FS5, which allows spectral and lifetime temperature maps to be automatically acquired.

**Top:** Automatic variable temperature emission scan of Rhodamine-B in H<sub>2</sub>O measured over a temperature range of +10°C to +80°C using the TE-cooled module. As the temperature is increased the diethylamino groups become increasingly mobile and the fluorescence intensity decreases.

**Bottom:** Automatically acquired temperature lifetime map of Rhodamine-B emission in H<sub>2</sub>O measured using the TE-cooled module.

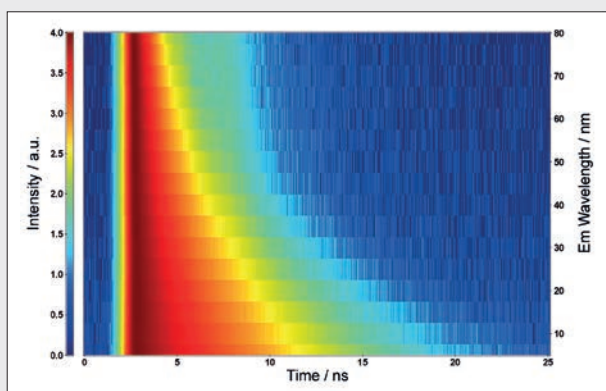
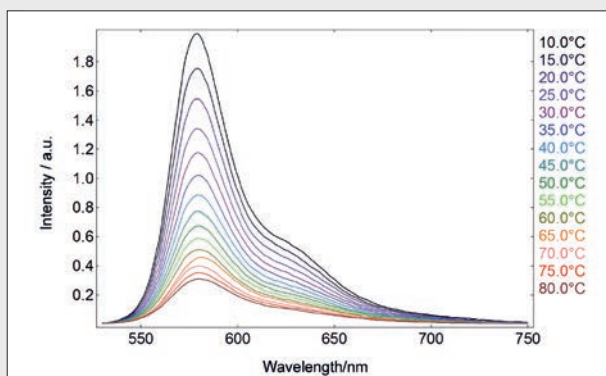

### Liquid Nitrogen Dewar (77K)

Designed for measuring the photoluminescence of solid samples and frozen solutions at cryogenic temperatures. The sample is held within a quartz tube which is immersed in liquid nitrogen. It is a low-cost alternative to traditional cryostats.

**Right:** Excitation and emission spectra of a small-molecule OLED emitter at 77K and 295K measured using the Dewar module. At cryogenic temperatures the rotational and vibrational broadening is reduced and the fine structure of the spectrum can be seen.

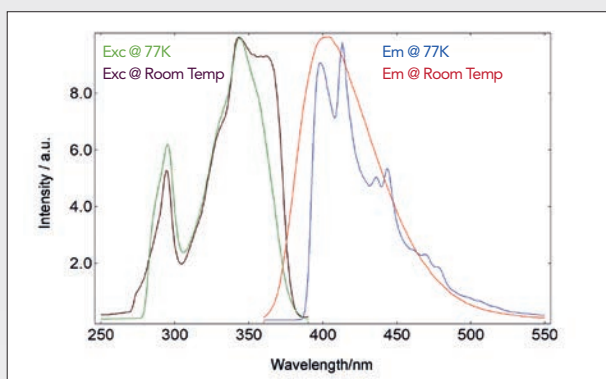

### Liquid Nitrogen Cryostat (77K to 500K)

This sample module incorporates a liquid nitrogen cryostat for the measurement of fluorescence of solutions and solid samples at cryogenic temperatures. The temperature is fully controlled by Fluoracle, allowing spectral and lifetime temperature maps to be automatically acquired.

**Right:** Variable temperature emission scans of the phosphor BaMgAl<sub>10</sub>O<sub>17</sub>:Eu acquired automatically using the cryostat module. The emission spectrum of the phosphor undergoes a bathochromic shift as the temperature is lowered.

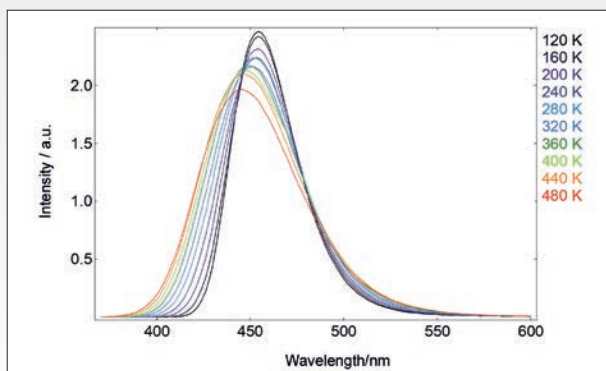

The FS5 upgrade options are modifications or additions to the main body of the FS5. All upgrades are best installed at the time of manufacture, but they can also be retro-fitted by a qualified service engineer during an on-site visit.

All the standard features of the FS5 are retained when an upgrade option has been added and many upgrade options can be combined. This offers outstanding flexibility for an instrument of this class.

## WAVELENGTH EXTENSION UPGRADES

### UV Wavelength Extension

Enhance and extend the range of UV excitation with an ozone-generating bulb and an excitation grating optimised for short wavelengths. With this combination excitation wavelengths < 200 nm can be used.

### NIR Wavelength Extension

Extend the detection range of the FS5 into the near-infrared. A range of options are available either replacing the standard PMT or adding a second detector operating in photon-counting or analogue mode.

- ➔ **PMT-EXT:** replaces the standard detector with an extended range PMT with coverage up to 980 nm.
- ➔ **FS5-NIR:** adds a second PMT detector and grating with coverage up to 1010 nm.
- ➔ **FS5-NIR+:** adds a second TE-cooled PMT and NIR grating with coverage from 950 nm - 1650 nm. We recommend combining this detector with the PMT-EXT option for optimal coverage at 900 nm – 1000 nm.
- ➔ **FS5-NIRA+:** adds an analogue detector and grating with coverage from 870 nm - 1650 nm in addition to the standard PMT. Further measurements beyond 1650 nm are also available. Steady state measurements only.

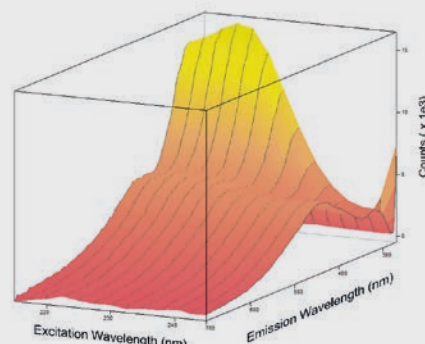

Excitation-Emission Map of wastewater after Enhanced Biological Phosphorus Removal (EBPR), acquired with UV enhanced excitation option. Sample provided by Prof. Alistair Elfick, School of Eng., University of Edinburgh.

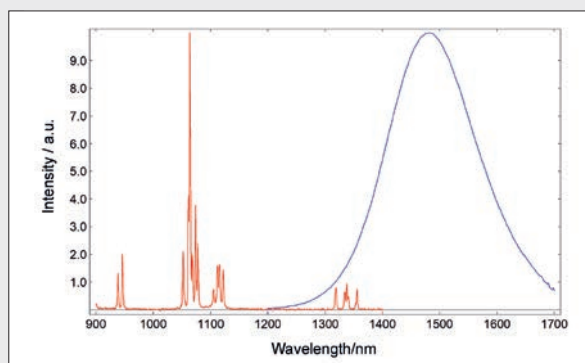

Peak-normalised spectra acquired with two different detector options in the NIR range: emission from PbS quantum dots in toluene with NIR+ (blue), and from Nd:YAG with NIRA+ (red). The analogue detector option (NIRA+) is suitable for high fluorescence intensities, while samples with low quantum yield benefit from a photon-counting detector (NIR+).

## FLUORESCENCE POLARISATION AND ANISOTROPY

- ➔ **FS5-POL:** Measure Fluorescence Anisotropy

This upgrade includes fully computerised polarisers in both the excitation and emission arms for fluorescence anisotropy studies.

Automated measurements and generation of anisotropy curves are supported by the software. If combined with the TCSPC option, time-resolved fluorescence anisotropy measurements and analysis will also be possible. Calcite polarising prisms with an operational range of 240 nm - 2300 nm are used for compatibility with all of the NIR emission upgrade options.

**Top:** Fluorescence Anisotropy measurement of Rhodamine 6G in glycerol at room temperature. Raw data for vertical (red) and horizontal (green) emission polarisation plane.

**Bottom:** Steady state anisotropy of excitation (blue) and emission (magenta).

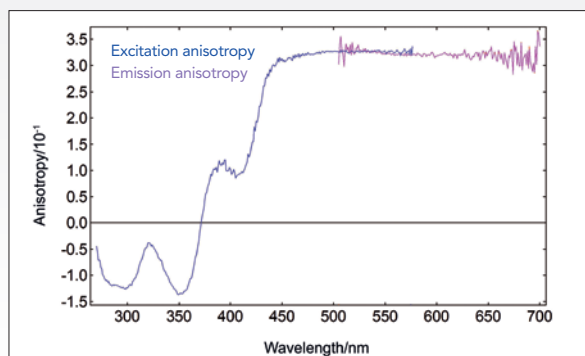
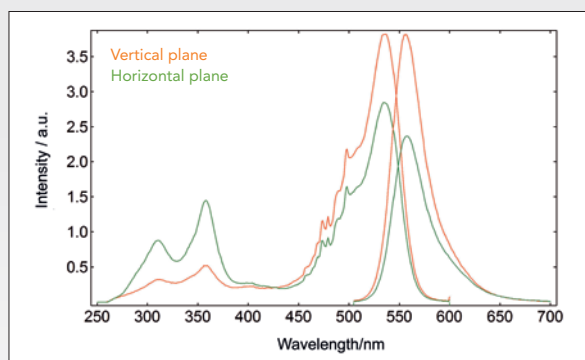

## LIFETIME EXTENSION UPGRADES

### FS5-MCS: Lifetimes from Microseconds to Seconds

Phosphorescence lifetime measurements in the lower microsecond (>5  $\mu$ s) to second time range is done by a technique called Multi-Channel Scaling (MCS). This upgrade features a microsecond xenon flashlamp as an additional excitation source. Lifetimes in the range of >5  $\mu$ s to <10 s can be measured and the software incorporates fitting and reconvolution analysis for lifetime evaluation.

Some luminescent samples or mixtures possess overlapping fluorescence and phosphorescence spectra. The FS5-MCS upgrade allows the user to isolate one component from the other using the Virtual Gating option available through software. Variable pulsed sources (VPL and VPLED Series) may be combined with the MCS upgrade.

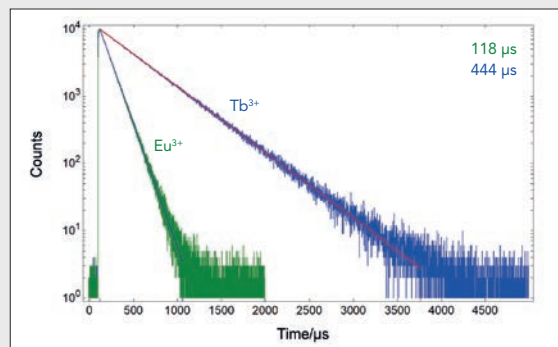

Luminescence decays of  $Tb^{3+}$  and  $Eu^{3+}$  ions and results of tail fit analysis. The samples were excited with the microsecond flashlamp.

### FS5-TCSPC: Lifetimes from Picoseconds to Microseconds

Fluorescence lifetime measurements in the picosecond, nanosecond and the lower microsecond (<10  $\mu$ s) time range is done by Time-Correlated Single Photon Counting (TCSPC). This requires picosecond pulsed diode lasers (EPL Series) and LEDs (EPLED Series) for excitation, which are attached to the FS5 housing as shown below, and come with a range of different output wavelengths. The software offers numerical reconvolution and curve fitting.

The FS5-TCSPC upgrade, allows lifetime measurements in the range of <150 ps to >10  $\mu$ s to be accurately measured (exact value depends on the pulsed source). The MCS and TCSPC upgrades can be combined. TCSPC sources such as the EPL and EPLED Series can be used in 'MCS mode' for lifetime measurements in the range of >100 ns.

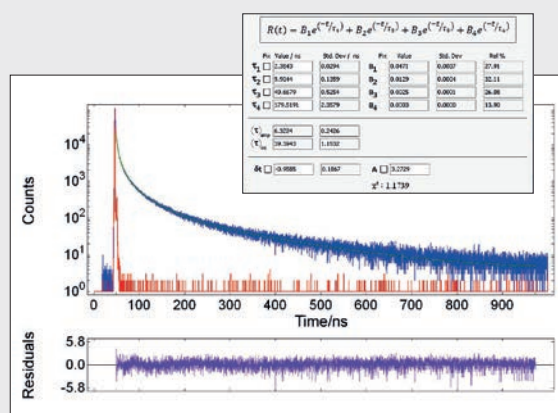

TCSPC decay and fit result in Fluoracel.

### FS5-TCSPC+: Lifetimes in the Lower Picosecond Range

For challenging applications, the FS5-TCSPC+ upgrade adds a second, faster detector, allowing lifetime measurements in the range of <25 ps to >10  $\mu$ s to be measured (exact value depends on the pulsed source used).

**Right:** Erythrosin B in ethanol-water solutions with varying concentrations of ethanol, using FS5-TCSPC+ fast detector and EPL-510 picosecond pulsed diode laser source.

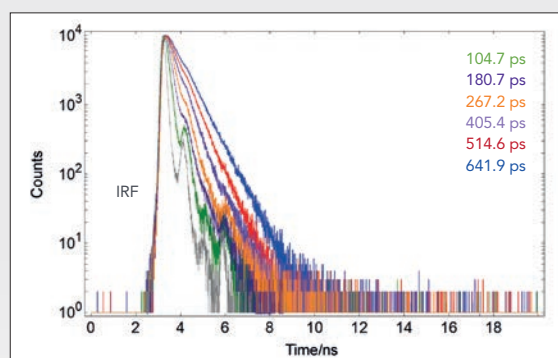

## SAMPLE MODULE RANGE

Sample modules containing a variety of sample holders are available for practically all applications.

These accessories can be purchased at any time and can easily be installed by the user. The installation takes no more than a few seconds for most of the modules.

The Fluoracle software automatically recognises which of the sample measurement modules is in use and adjusts the user interface accordingly. This reduces any complexity for the user and ensures ease of operation.

### STANDARD SAMPLE MODULES

- SC-05 Standard Cuvette Holder
- SC-06 Dual Sample Holder for Absorption
- SC-10 Solid Sample Holder (Upright/Tilted)
- SC-15 Solid Sample Holder (Horizontal)

### TEMPERATURE CONTROL MODULES

- SC-20 Thermostatic Sample Holder
- SC-25 TE-Cooled Sample Holder - Standard Range
- SC-26 TE-Cooled Sample Holder - Extended Range
- SC-27 TE-Cooled Sample Holder - 4-Position
- SC-28 Heated Sample Holder - Powders
- SC-70 Liquid Nitrogen EPR Dewar
- SC-80 Liquid Nitrogen Cryostat

### INTEGRATING SPHERE

- SC-30 Integrating Sphere

### PLATE READER

- SC-41 Microwell Plate Reader

### REMOTE SENSING / MICROSCOPE

- SC-50 Optical Fibre Launcher

### OTHER

- SC-60 Calibration Kit

Safety Interlock Feature



Front Loading Access

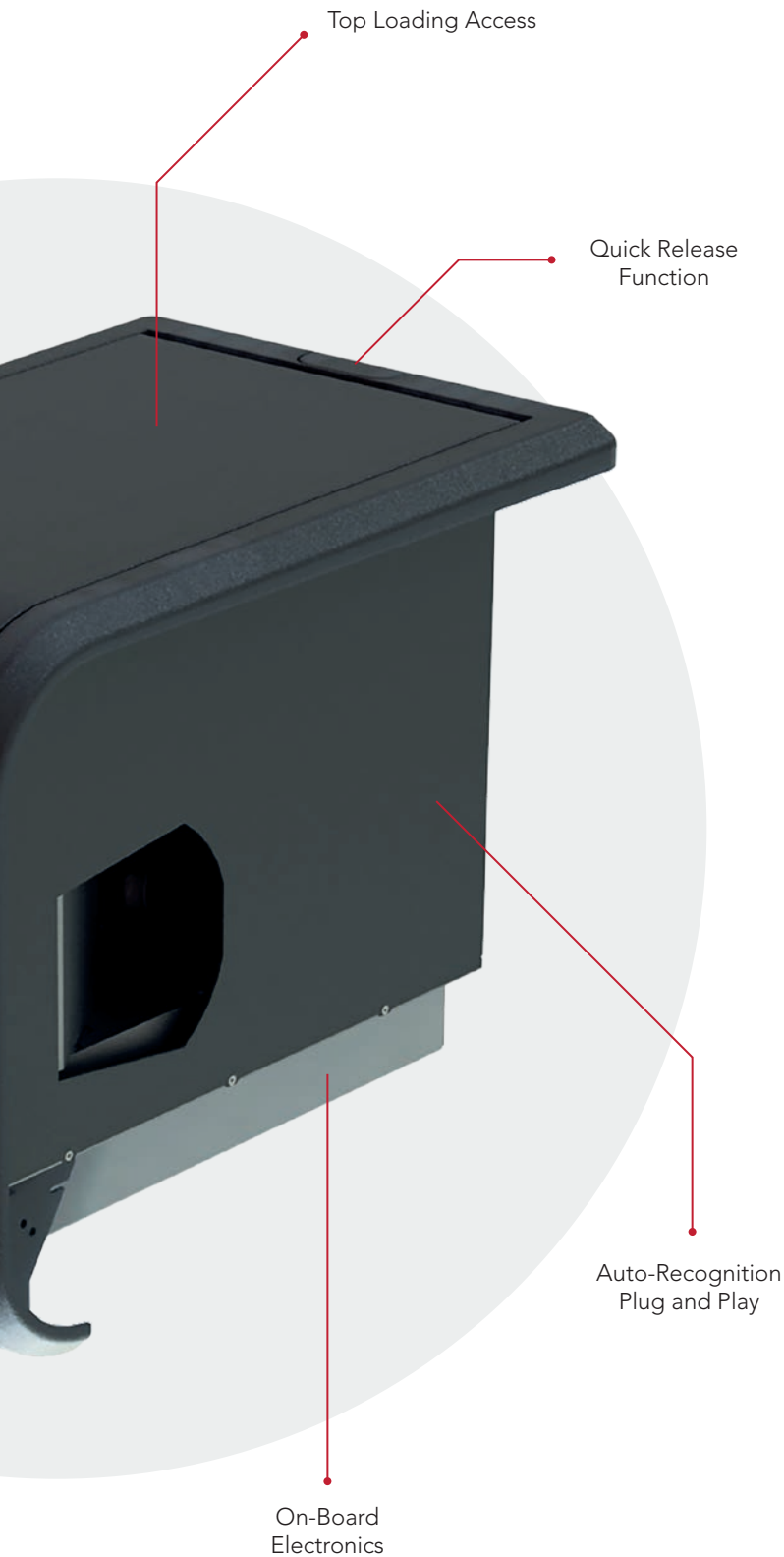

## SAMPLE HOLDERS

Sample holders are available for all solids, liquids, powders and thin-films. All sample types can be temperature controlled through a variety of in-house and third party holders and accessories.

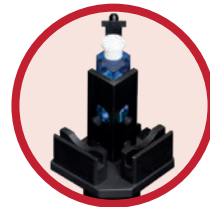

**Cuvette Holder (SC-05)**  
Liquid Samples

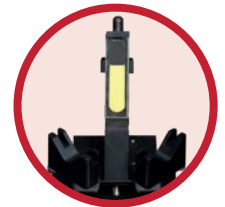

**Solid Sample Holder (SC-10)**  
Upright - Powders & Thin-Films

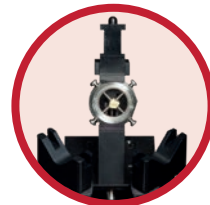

**Solid Sample Holder (SC-10)**  
Upright - Solids & Crystals



**Thermostatic Holder (SC-20)**  
Coolant Circulation -10°C to +60°C



**TE-Cooled Holder (SC-26)**  
-50°C to +150°C



**Liquid N<sub>2</sub> EPR Dewar (SC-70)**  
77K



**Liquid N<sub>2</sub> Cryostat (SC-80)**  
77K to 500K

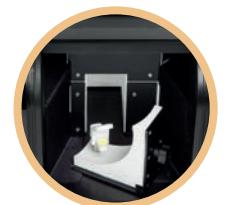

**Integrating Sphere (SC-30)**  
QY - Liquids, Solids and Powders



**Microwell Plate Reader (SC-41)**  
96-Well Plates



**Optical Fibre Launcher (SC-50)**  
Remote fibre interface to 3<sup>rd</sup> party accessories



## ACCESSORIES

### SCA-1 Solid Sample Holder

The SCA-1 replaces the standard cuvette holder of the SC-05 sample module. It is designed for photoluminescence and transmission measurements of solid samples and is an economical alternative to the SC-10 module.



### SCA-2 Solid Sample Holder with Rotation

The SCA-2 is an insert for the standard cuvette holder of the SC-05, SC-20, SC-25 and SC-26 sample modules, which enables the measurement of solid samples. It is a low-cost option for temperature control of solids.



### SCA-3 Syringe Port

The SCA-3 is an alternative top cover for the SC-05, SC-20, SC-25 and SC-26 sample modules that incorporates a light-tight feedthrough for syringes and pipettes. It is ideal for in-situ sample mixing and titration during measurements.



### SCA-6 Stopped-Flow

The SCA-6 is a stopped-flow accessory for measuring rapid reaction fluorescence and transmission kinetics with millisecond time resolution. It is available with a choice of 2 (standard) or 3 (multi-mixing) injection syringes and is compatible with the SC-05, SC-20, SC-25 and SC-26 sample modules.



### SCA-7 Solid Sample Holder with Rotation

The SCA-7 replaces the standard cuvette holder of the SC-05 sample module. It is designed for angular dependent photoluminescence and transmission measurements of solid samples.



### SCA-8 Electroluminescence Sample Holder

The SCA-8 is an additional sample holder for the SC-30 integrating sphere sample module. It is used for electroluminescence quantum yield measurements of solids and thin-films materials. Two electrical contacts are used with a 25 mm x 20 mm sample space.



## SPECIFICATIONS

<b>STANDARD CONFIGURATION</b>	Optics	All-reflective for wavelength independent focus with high brightness (small focus) at the sample
	Detection Technique	Single Photon Counting
	Light Source	150 W CW Ozone-free Xenon arc lamp
	Monochromators	Czerny-Turner design with dual grating turret; plane gratings for accurate focus at all wavelengths and minimum stray light
	Spectral Coverage - Excitation	230 nm - 1000 nm
	Spectral Coverage - Emission	200 nm - >870 nm
	Filter wheels	Fully automated; included in both the excitation and emission monochromators
	Bandpass - Excitation/Emission	0 - 30 nm, continuously adjustable
	Wavelength Accuracy	± 0.5 nm
	Scan Speed - Excitation/Emission	100 nm/s
Integration Time	from 1 ms	
<b>DETECTORS</b>	Emission Detector	Single Photon Counting, PMT-900, cooled and stabilised, 200 nm - 900 nm
	Reference Detector	UV enhanced silicon photodiode, 200 nm - 1000 nm
	Absorbance Detector	UV enhanced silicon photodiode, 200 nm - 1000 nm
	Absorbance Range	0 - 2 A
	Absorbance Accuracy	± 0.01 A
<b>SENSITIVITY</b>	Water Raman Signal	400,000 cps at 397 nm emission, excitation 350 nm, 5 nm bandpass, 1 s integration time
	Signal-to-Noise Ratio	>6,000:1 (SQRT)
<b>DIMENSIONS</b>	W x D x H	104 cm x 59 cm x 32 cm
	Weight	55 kg

## UPGRADE SPECIFICATIONS

<b>EXCITATION WAVELENGTH EXTENSION</b>	Model	<b>FS5-UV</b>			
	Source	150 W CW Ozone generating Xenon bulb			
	Excitation Coverage	<200 nm – 1000 nm			
<b>EMISSION WAVELENGTH EXTENSION</b>	Model	<b>PMT-EXT</b>	<b>FS5-NIR</b>	<b>FS5-NIR+</b>	<b>FS5-NIRA+</b>
	Emission Coverage	200 nm - >980 nm	200 nm - >870 nm plus 600 nm - >1010 nm	200 nm - >870 nm plus 950 nm - >1650 nm	200 nm - >870 nm plus 870 nm - >1650 nm
		PMT-EXT replaces standard PMT-900	–	NIRA+ for spectral measurements only, PMT-EXT recommended with NIR+ and NIRA+ options	
<b>POLARISATION / ANISOTROPY</b>	Model	<b>FS5-POL</b>			
	Computer Control	In/Out of beam, polarisation angle 0° - 90°			
	Spectral Coverage	240 nm - 2300 nm (excitation and emission)			
<b>PHOSPHORESCENCE LIFETIME</b>	Model	<b>FS5-MCS</b>			
	Sources	Microsecond Xenon flashlamp Picosecond pulsed diode lasers (EPL Series) Picosecond pulsed LEDs (EPLD Series) Variable pulse sources (VPL/VPLD Series)			
	Lifetime Range	< 5 µs - > 10 s			
<b>FLUORESCENCE LIFETIME</b>	Model	<b>FS5-TCSPC</b>		<b>FS5-TCSPC+</b>	
	Sources	Picosecond pulsed diode lasers (EPL Series) Picosecond pulsed LEDs (EPLD Series)		Picosecond pulsed diode lasers (EPL Series) Picosecond pulsed LEDs (EPLD Series)	
		< 150 ps - 10 µs		< 25 ps - > 10 µs	

---

## EDINBURGH INSTRUMENTS

2 Bain Square,  
Kirkton Campus,  
Livingston, EH54 7DQ  
United Kingdom

Tel: +44 (0)1506 425 300  
Fax: +44 (0)1506 425 320

[sales@edinst.com](mailto:sales@edinst.com)

## U.S. OFFICE CONTACT:

Tel: +1 800 323 6115  
Fax: +44 (0)1506 425 320

[ussales@edinst.com](mailto:ussales@edinst.com)



---

Customer support is  
available worldwide

[edinst.com](http://edinst.com)

Registered in England and Wales No: 962331 VAT No:GB 271 7379 37  
©Edinburgh Instruments Ltd 2020

F / 07.2020

