

Kuro

Back-illuminated scientific CMOS cameras

Datasheet



TELEDYNE
PRINCETON INSTRUMENTS
Everywhereyoulook™

Breakthrough Technology



KURO™, from Princeton Instruments, is the world's first back-illuminated scientific CMOS (sCMOS) camera system with up to 2048 x 2048 pixel resolution and exceptionally low 1.3 e- read noise. The KURO 1200B delivers high frame rates of 82 fps (12 bits) or 41 fps (16 bits), whereas the KURO 2048B delivers 47 fps (12 bits) or 23 fps (16 bits). These cameras are controlled by our powerful, 64-bit LightField software and are capable of delivering hundreds of fps with custom ROI. They are ideal for many challenging high speed, low-light imaging and spectroscopy applications.

Applications include:

Hyperspectral imaging | Astronomy | Cold-atom imaging | Quantum imaging | Fluorescence spectroscopy | High-speed spectroscopy

Outstanding UV response

The elimination of the need for microlenses (thanks to back illumination) means the KURO offers outstanding response in the ultraviolet range. Microlenses transmit very poorly (or not at all) below 400 nm.

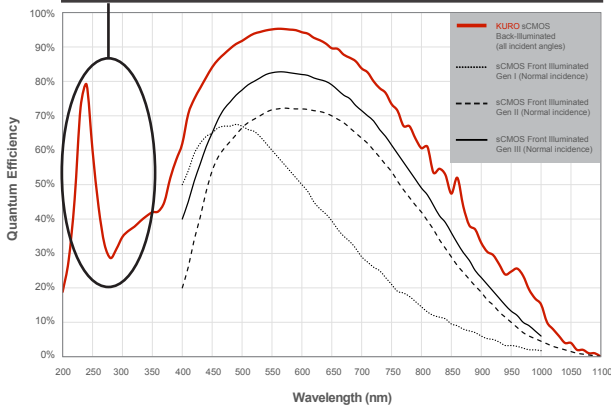

Back-illuminated sCMOS detector with >95% peak QE

The KURO features a back-illuminated sensor architecture just like that of the most sensitive CCD detectors available. The back-illuminated technology utilized by the KURO allows this next-generation sCMOS camera system to deliver >95% quantum efficiency (QE) and 100% fill factor.

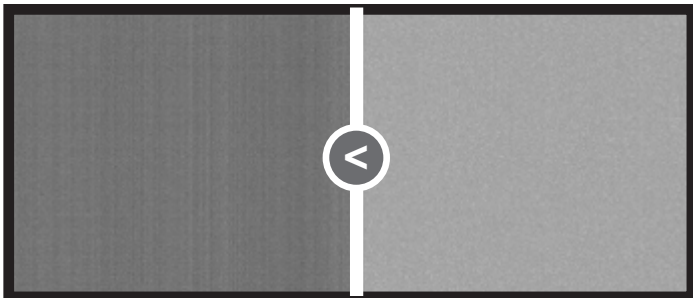

Reduced fixed-pattern noise

The KURO uses the latest sCMOS fabrication technology along with optimized electronics. As a result, it has a significantly better noise profile than any previous-generation, front-illuminated sCMOS camera.

100 frame average of front-illuminated sCMOS camera

Kuro

No microlenses on pixels

Unlike front-illuminated sCMOS cameras, which claim ~80% peak QE, the KURO does not use microlenses to recapture light from the masked area of the pixel. Microlenses significantly degrade QE when light is incident at any angle other than normal to the sensor surface.

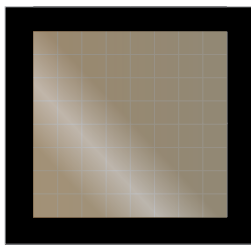
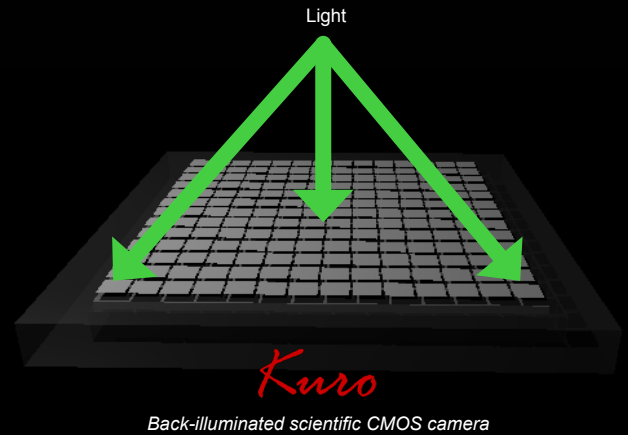
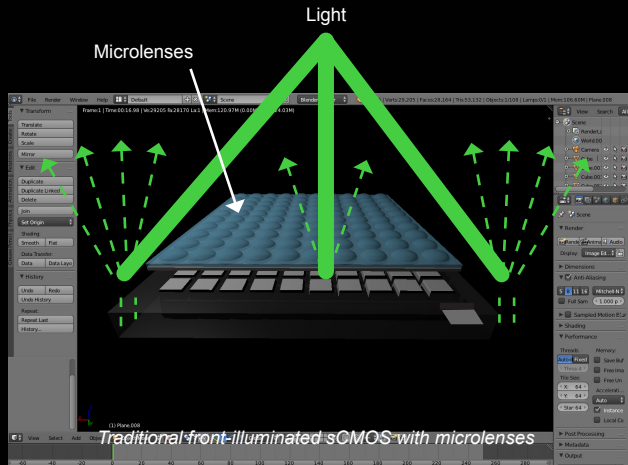

Previous-generation sCMOS pixel ($6.5 \mu\text{m}^2$)

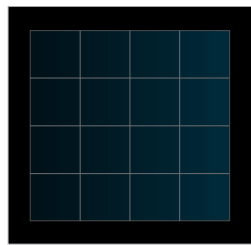

Kuro
Back-illuminated sCMOS pixel ($11 \mu\text{m}^2$)

Large pixels and wide dynamic range

The $11 \mu\text{m}^2$ pixel pitch of the KURO sensor captures 2.8x more photons than previous-generation sCMOS sensors. Each pixel can also handle a large full well of 80,000 electrons, allowing excellent dynamic range (61,500:1 or 95 dB).

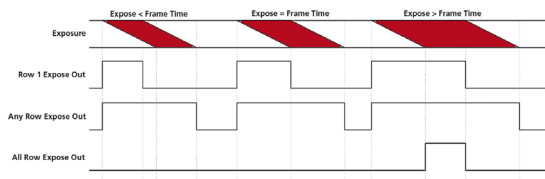

Flexible trigger modes

The KURO provides a full suite of input-output TTL signals. These signals make it easy to synchronize camera operation with external events or light sources.



Optimized for spectroscopy*

Scientific CMOS sensors typically do not support on-chip binning. However, the KURO camera's low read noise and support of software binning (off-chip binning) make it ideal for high-speed spectroscopy applications. Furthermore, the pixel pitch of its sensor is a perfect match for optimal use with the award-winning, aberration-free IsoPlane[®] spectrometer from Princeton Instruments.

*KURO 1200B



Powered by LightField[®]

Designed for operation within the Princeton Instruments LightField software ecosystem, the KURO is easy to control and can be integrated quickly in myriad imaging and spectroscopy experiments. Camera integration for use with both MATLAB[®] (MathWorks) and LabVIEW[®] (National Instruments) is also fast and simple.

KURO Specs

Feature	KURO 1200B	KURO 2048B
Sensor	1200 x 1200 back-illuminated scientific CMOS	2048 x 2048 back-illuminated scientific CMOS
Imaging area	13.2 x 13.2 mm	22.53 x 22.53 mm
Bit depth	12 bit; 16 bit	12 bit; 16 bit
Frame rates @ full resolution (more frame rates on pg. 5)	82 fps / 12 bit, 41 fps / 16 bit	47 fps / 12 bit, 23 fps / 16 bit
Exposure time	10 sec	30 ms
Pixel size	11 x 11 μm	
Pixel fill factor	100%	
Full well	80,000 e-	
Window	Single window in the optical path; UV-grade fused silica	
Readout noise	1.3 e- rms (median); 1.5 e- rms	
Readout modes	Rolling shutter; effective global shutter	
Binning	Yes (software binning only)	
Data interface	High-speed USB 3.0	
Trigger modes	Start on single trigger; readout per trigger	
TTL output signals	EXPOSE (first row, any row, all rows); READOUT; READY; SHUTTER OUT	
Sensor cooling	-10°C (with air); -25°C (with liquid assist)	
Fan control	Software-selectable fan speeds	
Dark current	1.9 e-/p/s @ -10°C; 0.7 e-/p/s @ -25°C	
Software supported (sold separately)	Princeton Instruments LightField (optional); LabVIEW (National Instruments) and MATLAB (MathWorks) supported via automation	
SDK	PICam (available for free)	
Operating system	Microsoft® Windows® 7/8/10 (64 bit)	
Operating conditions	0°C to 30°C; 80% RH non-condensing	
Lens Mounts	C-mount (standard); C-to-spectrometer mount (optional); C-to-F mount (optional)	F-mount (standard); C-to-spectrometer mount (optional); C-mount (optional)
Dimensions / weight	L x W x D: 6.15" (156.2 mm) x 4.04" (102.6 mm) x 4.04" (102.6 mm); 3.8 lbs (1.7 kg)	L x W x D: 7.30" (185.4 mm) x 4.04" (102.6 mm) x 4.04" (102.6 mm); 3.8 lbs (1.7 kg)

Quantum Efficiency Curve

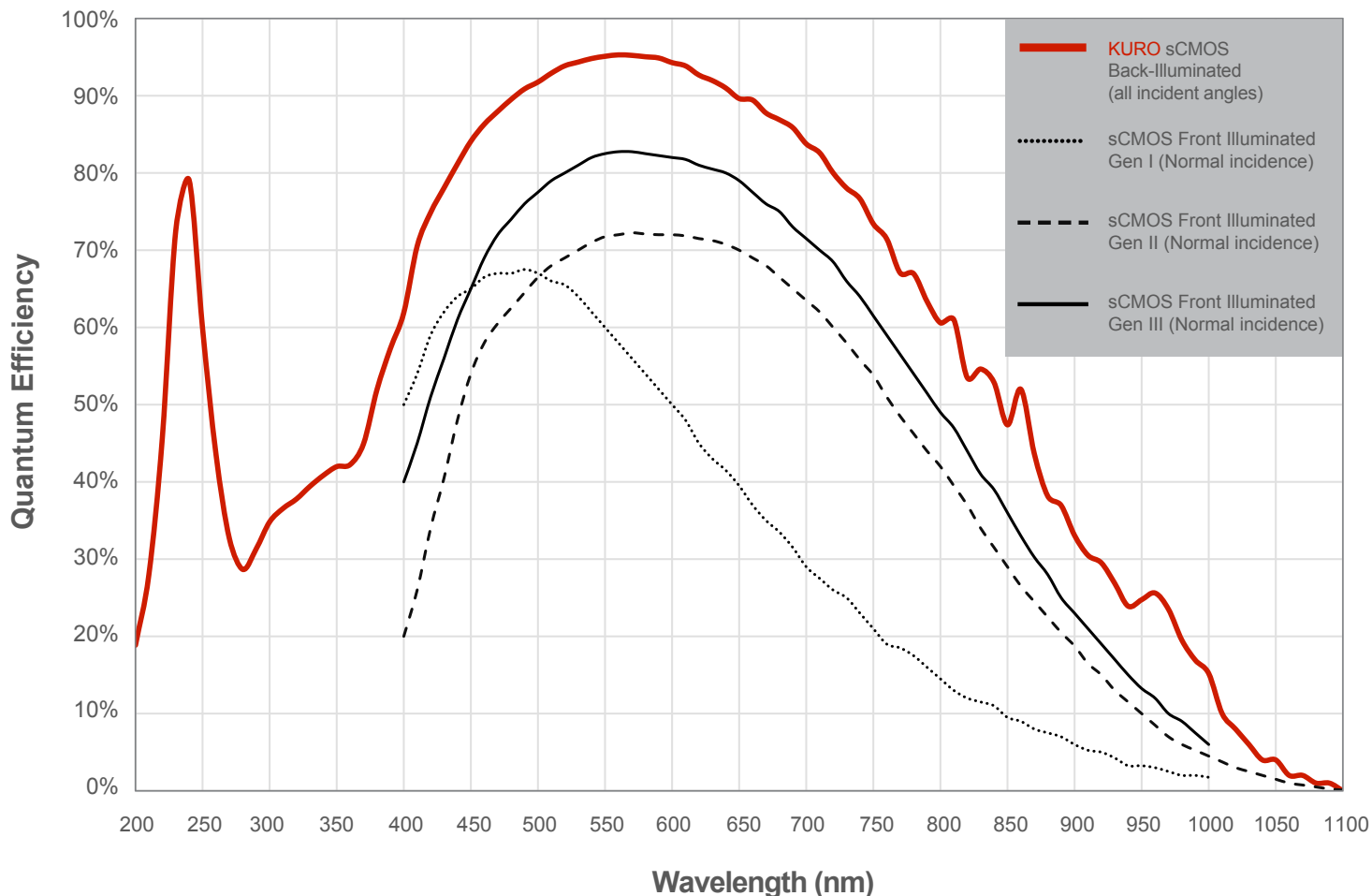

Note:
Graph shows typical QE data measured at +25°C. QE decreases at normal operating temperatures. For the best results for your application, please discuss the specific parameters of your experiment with your Princeton Instruments representative.

High speed, great sensitivity and low read noise
The ultimate combination!

KURO is the only camera on the market that combines 2k x 2k resolution with very high frame rates, 95% QE, and 1.3 e- rms read noise.

Resolution	Frame rate: fps (12 bit)	Frame rate: fps (16 bit)
2048 x 2048	47	23
2048 x 1024	95	47
2048 x 512	190	95
2048 x 256	380	190
2048 x 128	760	380
2048 x 64	1520	760
2048 x 32	n/a	1470
2048 x 16	n/a	2560
1200 x 1200	82	41
1200 x 512	190	96
1200 x 256	384	192
1200 x 128	760	384
1200 x 64	1470	760
1200 x 32	2860	1470
1200 x 16	4420	2560

Outline Drawings

KURO 1200B Drawing

LEFT

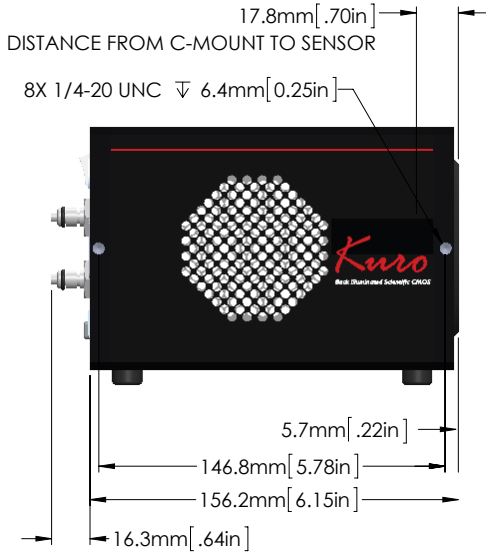

FRONT



RIGHT



KURO 2048B Drawing

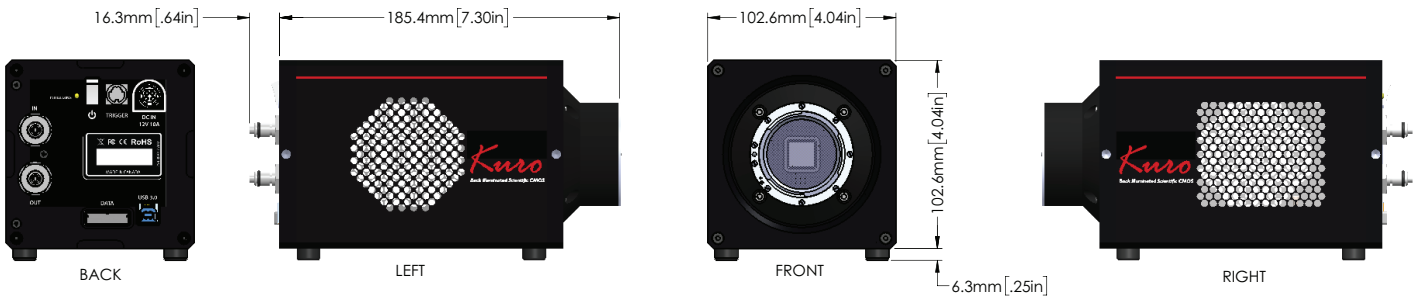
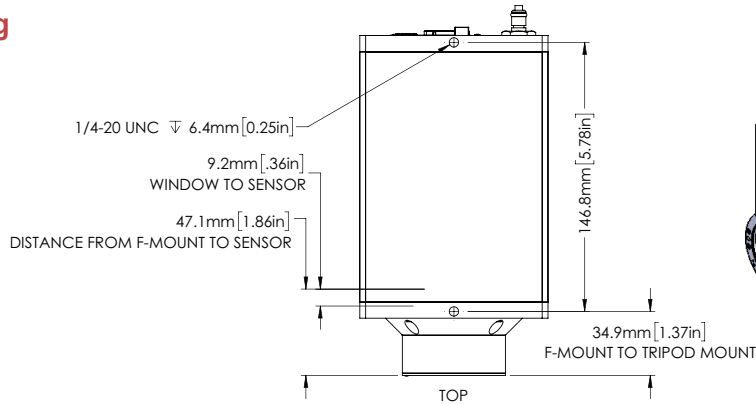

Rolling Shutter

Like many sCMOS sensors, the KURO sensor uses a rolling shutter mode for exposure-readout operations. This mode allows lower read noise; however, it does not allow “simultaneous” exposure of pixels. The following diagram and table describe the rolling shutter timing used by the KURO camera.

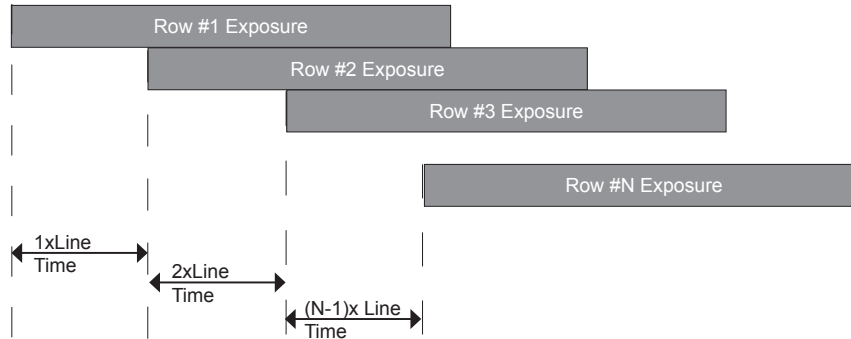

Row #	Exposure Start time	Exposure End time
1	TO	TO+EXP TIME (user entered value)
2	TO+(1xLINE TIME)	TO+(1xLINE TIME)+EXP TIME
3	TO+	
N	TO+(N-1 * LINE TIME)	TO+(N-1xLINE TIME)+EXP TIME

Effective Global Shutter

The KURO provides programmable TTL output signals that can be employed to synchronize the camera with external events or light sources. The EXPOSE OUT signal can be programmed as follows...

FIRST ROW EXPOSE: The signal is high as long as the first row of the frame is exposed.

ANY ROW EXPOSE: The signal is high from the start of the first row exposure to the end of the last row exposure.

ALL ROWS EXPOSED: The signal is high to indicate ALL sensor rows are exposed. This is useful as a strobe pulse to control an external light source and obtain “effective global shutter” operation.

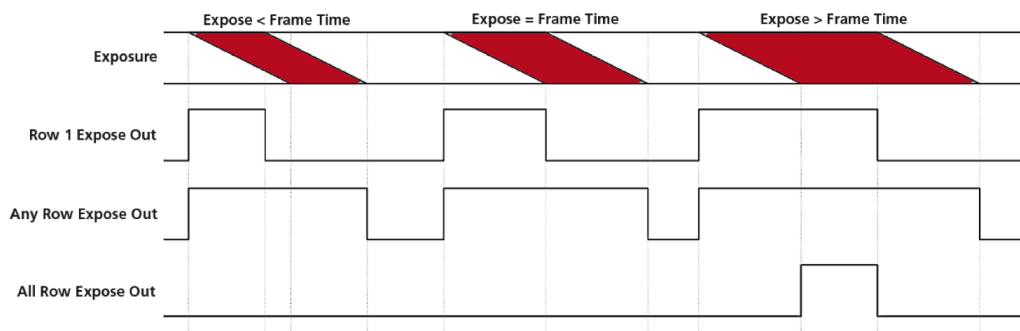

See KURO technical note at princetoninstruments.com

LightField[®] Software

The combination of Lightfield and Kuro provides researchers with the most advanced and reliable toolset for experimental setup, data acquisition and post processing.

- ▶ Powerful 64-bit software package including Windows[®] 10 support
- ▶ Complete control of Princeton Instruments cameras and spectrometers
- ▶ Dependable data integrity via automatic saving to disk, time stamping and retention of both raw and corrected data
- ▶ Full experimental details and system settings are archived and can be reloaded for future experiments insuring maximum reproducibility
- ▶ For light-sensitive experiments, the user interface offers “low light” and “no light” modes during data acquisition
- ▶ LightField works seamlessly in multi-user facilities, remembering each user’s hardware and software configurations
- ▶ Simple math functions to complex transforms can be applied to live or stored data, along with an easy-to-use editor to create your own formulas
- ▶ Integrated LabVIEW[®] (National Instruments) and MATLAB[®] (MathWorks) support
- ▶ Exports to your favorite file formats including TIFF, FITS, ASCII, AVI, IGOR and Origin
- ▶ Demo camera mode allows the user to view all of the settings and parameters associated with any camera without physically connecting the camera
- ▶ Live data processing operations provide real-time evaluation of incoming data to optimize experimental parameters

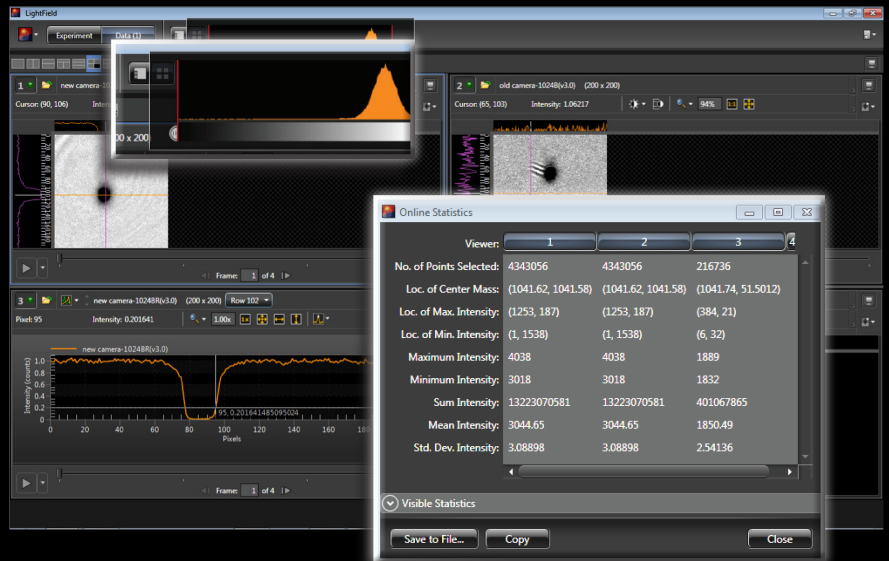

What is in the box?



Typical C-mount camera option shown in image.

Kuro

Back-illuminated scientific CMOS camera

Contact your local Princeton Instruments representative for additional information.

Princeton Instruments - USA

Tel: +1 609.587.9797
pi.info@teledyne.com

China

Tel: +86 157 21 5353 43
pi.info.china@teledyne.com

France

Tel: +33.1.70.38.19.00
EVR@teledyne.com

Germany

Tel: + 49 (0) 89-660 779 3
pi.germany@teledyne.com

Japan

Tel: +81.3.5639.2741
PI.Nippon@teledyne.com

United Kingdom

Tel: +44 (0) 7810 835 719
pi.info@teledyne.com



revA2.3

Copyright © 2017 Princeton Instruments, Inc. All rights reserved. KURO is a trademark and IsoPlane and LightField are registered trademarks of Princeton Instruments, Inc. Microsoft and Windows are registered trademarks of Microsoft Corporation in the United States and other countries. All other brand and product names are the trademarks or registered trademarks of their respective owners and manufacturers.