



EDINBURGH
INSTRUMENTS

TRANSIENT ABSORPTION SPECTROMETER

LP980



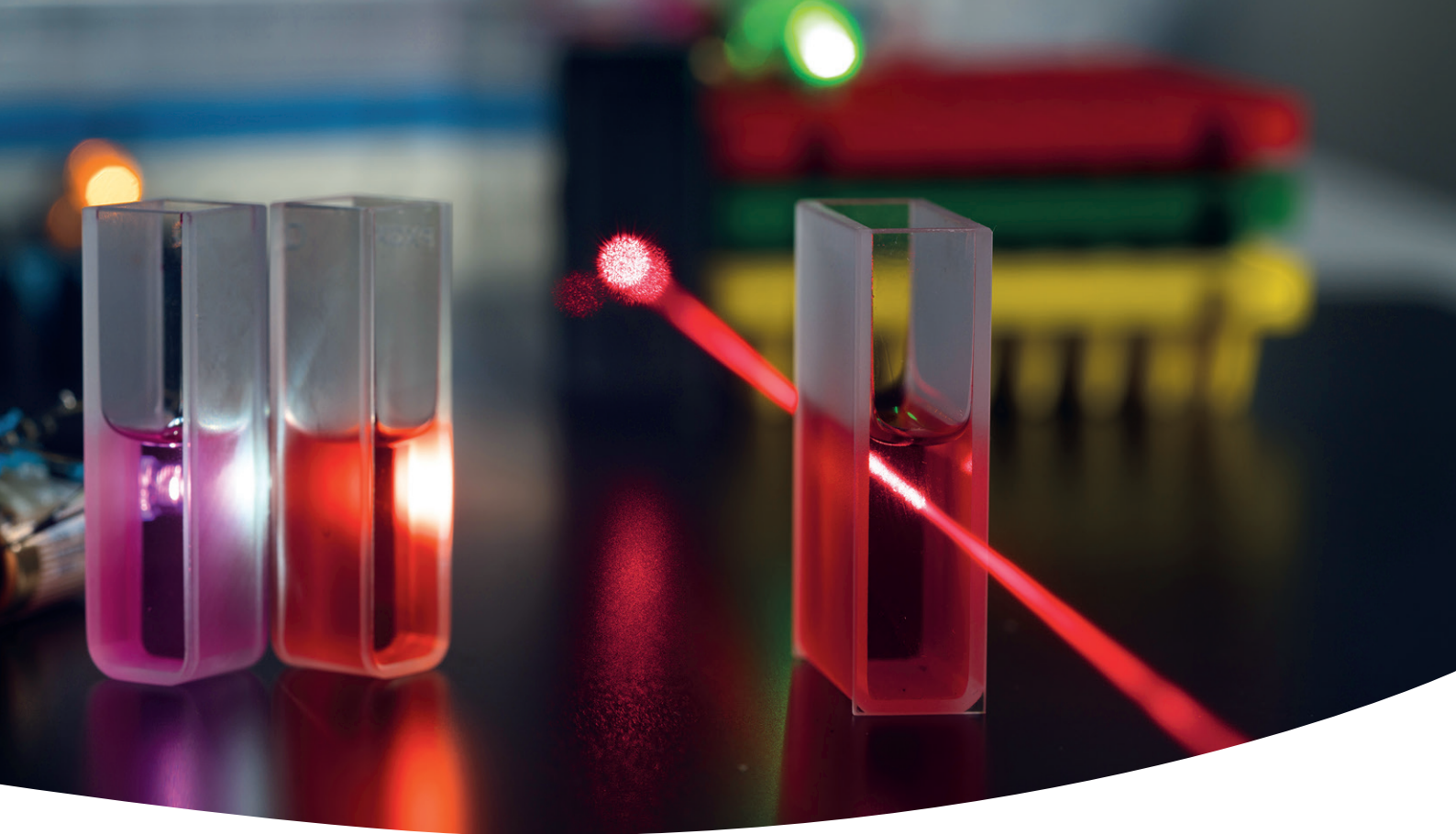

2

LP980-K TRANSIENT ABSORPTION SPECTROMETER – KINETIC MODE

Spectrometer system for measurements of transient absorption and laser-induced emission kinetics with the ability to automatically generate transient spectra.

10

LP980-SYSTEM OVERVIEW TRANSIENT ABSORPTION SPECTROMETER

Configuration, layout, and specifications for the turn-key, modular and unrivalled spectrometer.

14

LP980-KS TRANSIENT ABSORPTION SPECTROMETER – KINETIC AND SPECTRAL MODE

Spectrometer system for direct measurements of time-gated transient absorption and laser-induced emission spectra as well as kinetic measurements.

ABOUT THE LP980

As a fully computer-controlled turn-key system, the LP980 sets the standard for technical performance in transient absorption / laser flash photolysis.

Comprehensive software allows for astonishing ease of use and the modular design concept enables maximum flexibility, with unrivalled measurement modes all in one instrument:

- > Transient Absorption (TA)
- > Laser-Induced Fluorescence (LIF)
- > Photon Counting Phosphorescence

TRANSIENT ABSORPTION / LASER FLASH PHOTOLYSIS

TECHNICAL OVERVIEW

Transient Absorption / Laser Flash Photolysis is a technique for studying the transient chemical and biological species generated by a short, intense light pulse from a nanosecond pulsed laser source (pump pulse). This intense light pulse creates short lived photo-excited intermediates such as excited states, radicals, and ions. These intermediates are generated in concentrations large enough for chemical and physical interaction to occur and for direct observation of the associated temporally changing absorption characteristics.

These absorption changes are recorded using a spectrally continuous xenon lamp (probe source) forming the background in a single beam absorption spectrometer. The probe source is operated in a pulsed mode to enhance the photon flux for measurements in short time ranges, allowing spectra and kinetics to be measured with temporal resolutions from nanoseconds to milliseconds in pulsed mode, and milliseconds to seconds in continuous mode.

Transient Absorption (TA) measurements are applicable to liquid, gaseous, and solid samples. Liquids are usually measured in a cuvette with the pump beam and the probe beam overlapping orthogonally (transverse excitation). In gaseous samples the concentration of the participating molecules is much lower and a co-linear setup between the pump and probe beam is preferred to improve the signal to noise ratio.

Powders and non transparent bulk samples are generally studied in a diffuse reflectance setup. Dedicated film sample holders are available.

There are two modes of operation of the LP980:

- ① Kinetic mode - LP980-K
- ② Kinetic and Spectral mode - LP980-KS

Kinetic Data Acquisition

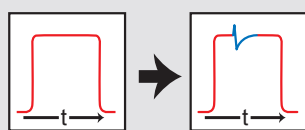

Kinetic Mode: TA decays are recorded at a single wavelength as a function of time using a photodetector and a digital storage oscilloscope. This mode provides very accurate measurement of transient kinetics since a complete time-resolved measurement of the transients is made in a single flash experiment. Lifetimes from nanoseconds to seconds can be measured over a wavelength range from 230 nm - 2550 nm (depending on the detector).

Spectral Data Acquisition

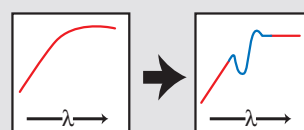

Spectral Mode: Time-gated TA spectra are measured at a specific time after excitation using an ICCD detector. Spectral mode measurements provide the full picture of the transient spectral features by exposing the sample to only a few laser shots. This is especially useful when studying biological samples, which can easily undergo photo-degradation under high levels of light. Time resolutions down to 3 ns can be achieved with a spectral coverage from 230 nm - 930 nm.

Spectral Slicing

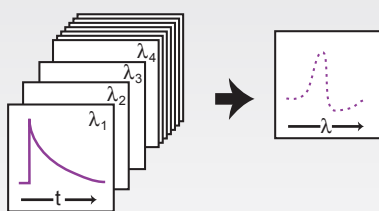

Time-resolved absorption spectra can be generated in kinetic mode laser flash experiments by automatic scanning through a pre-defined spectral range and subsequent data slicing. This technique requires many laser shots, in particular when high spectral resolution is required.

Kinetic Slicing

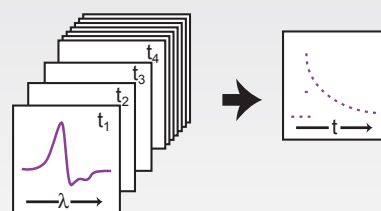

Spectrally resolved absorption kinetics can be extracted from spectral mode measurements by automatically stepping the gate delay through a predefined time range. Subsequent data slicing reveals the details of the transient absorption kinetics.

OVERVIEW

The LP980 Transient Absorption (TA) Spectrometer uses the same basic optical-electrical setup for operation in both the kinetic and the spectral mode, i.e. laser excitation source, probe source, sample compartment (including optics, attenuators, laser shutter, and probe shutter), monochromator / spectrograph, and control electronics. The difference between the two modes is the detector and the data acquisition electronics.

In kinetic mode a PMT detector is used and the transients are acquired using a fast, high resolution oscilloscope.

The LP980-K has been designed to meet the stringent demands of high quality research. At the same time it is a true turn-key system suitable for routine applications, with ease of operation guaranteed by comprehensive software and a user friendly interface.

OPERATIONAL EXAMPLE

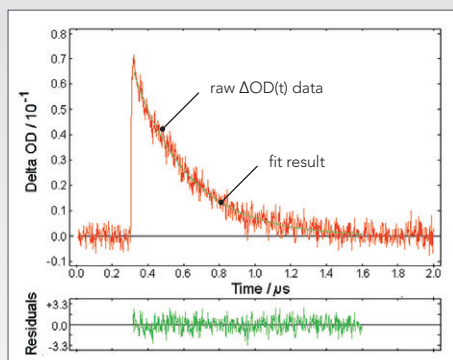
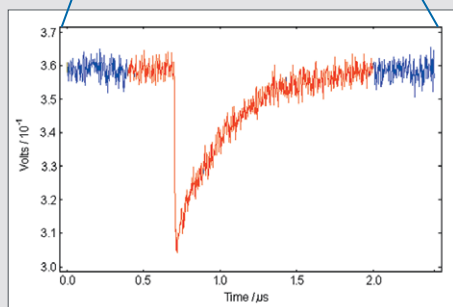
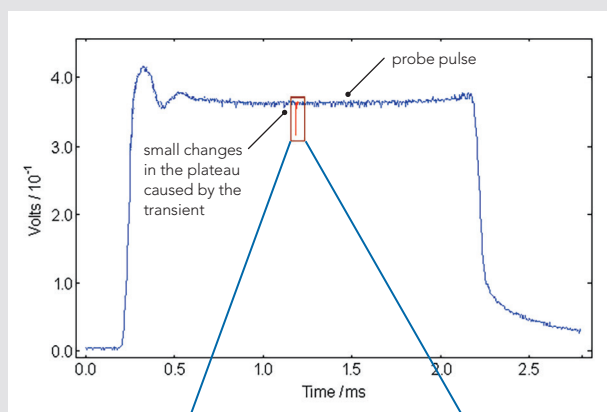

The sample being investigated is exposed to an intense laser pump pulse, which creates the transient species, and the probe source, which forms the background for the time dependent absorption measurement.

For time scales in the microsecond and nanosecond range the required high background level of the probe light is created by the intense flash from the pulsed xenon lamp which – after some stabilisation period - reaches a sufficiently flat plateau. This plateau level represents the pre-photolysis background level of the transmitted light through the sample. At a pre-set time after lamp triggering, when the pulse plateau is flat, the excitation laser is triggered creating the transient species under investigation. The absorption of the transient species is usually time dependent and produces a time dependent change in the transmission of the sample.

After recording the time dependent transmission of the sample, the optical density change is calculated using the level of the background light as 100% and the measurement baseline as 0%.

The change in optical density, ΔOD , can then be analysed using exponential least squares fitting algorithms, resulting in transient lifetimes or rate constants.

To protect the sample against unnecessary radiation exposure between measurements and as a means to control background measurements, high speed shutters are operated to control the probe and laser beam prior to entering the sample. For laser-induced emission measurements the probe shutter remains permanently closed.

SIGNAL DETECTION AND DATA ACQUISITION

The LP980-K is supplied as standard with a red sensitive PMT which covers the spectral range from 200 nm - 870 nm. The detector housing also accommodates the high voltage power supply and the voltage divider circuit.

The PMT detector system is designed to achieve a high dynamic range with exceptional current linearity. This is an essential requirement in measuring small signals on a large signal background. The voltage divider and power supply are configured to support this high linearity current mode by operating in a five stage dynode configuration.

The PMT detector contains two outputs within the same unit. The fast output has a rise-time of <3 ns and is suitable for transients up to ca. 1 ms. The slow output has a selectable range of output rise times and is recommended for timescales >1 ms, due to its improved signal to noise ratio. The rise times vary for ca. $10 \mu\text{s}$ - 10 ms with corresponding relative gains, varying from 1 to 1000.

Extended range PMTs with cut-off wavelengths at 980 nm and 1010 nm are available, as well as an option from 400 nm to 1200 nm. InGaAs detectors are available for transient absorption and emission measurements in the near-infrared spectral region (up to 2550 nm). A photon-counting NIR-PMT with 1650 nm cut off is recommended for NIR laser-induced fluorescence measurements.

DETECTION LIMIT

The detection limit given by the RMS noise for single shot measurements is $\Delta\text{OD} = 0.002$ (fast detector) and $\Delta\text{OD} = 0.0005$ (slow detector option).

Data averaging is common in transient measurements in order to improve the measurement's signal-to-noise ratio. For TA measurements this improves the detection limit by decreasing the minimum ΔOD that can be resolved.

Detection improvement is made in proportion to the number of pulses used in the measurement, e.g. 100 pulses improves the signal-to-noise ratio by ten times and hence the detection limit improves to $\Delta\text{OD} = 0.0002$ (fast detector) and $\Delta\text{OD} = 0.00005$ (slow detector).

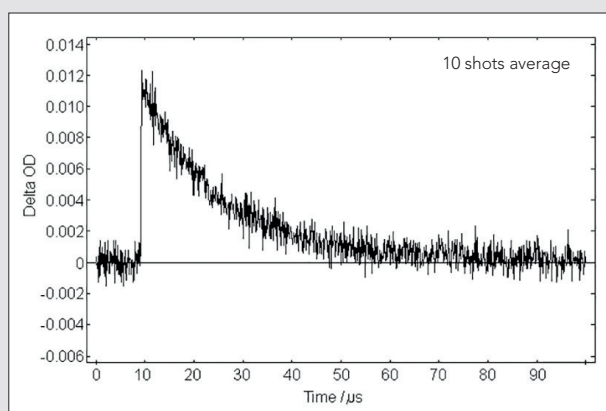
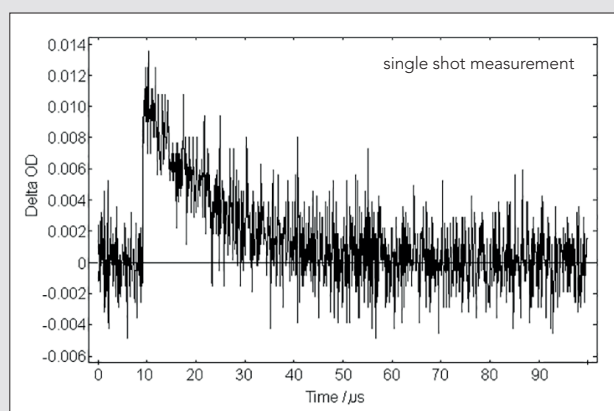

Demonstration of the detection limit and of the Signal-to-Noise improvement by signal averaging using the fast detector version

Sample: Erythrosin B in water

Measurement Conditions: $\lambda_{\text{pump}} = 532$ nm, $E_{\text{pump}} = 1$ mJ, pulsed probe source, $\lambda_{\text{probe}} = 580$ nm

SOFTWARE

The LP980-K spectrometer system is fully computer-controlled by means of the comprehensive L900 software package.

A variety of different measurements and correction methods are available. For example, if the probe shutter is programmed to be closed during the measurement then normal time-resolved emission measurements can be made. If a measurement sequence is made with alternate switching between probe shutter open and probe shutter closed then the result is a measurement of TA which is corrected for emission. The LP980-K data acquisition dialogue boxes allow the direct import of data captured with the digital storage oscilloscope.

Data averaging can be made either within the oscilloscope in order to make effective use of high repetition rate sources, or the data can be transferred to the computer memory and averaged there. At the end of a measurement sequence, the raw data is converted into optical density data.

The L900 software package offers a comprehensive library of data analysis routines, including 1 to 4-exponential and reconvolution fits, analysis of growth and decay kinetics.

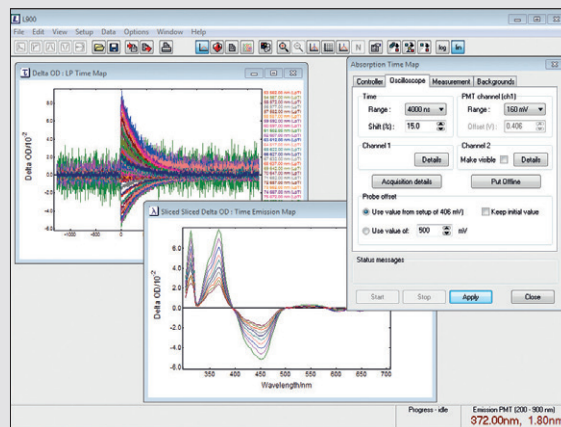
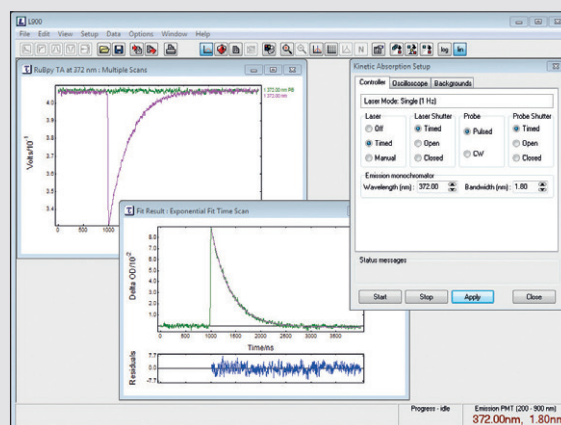

SOFTWARE FUNCTIONALITY

The main challenge for the L900 software and the LP980 spectrometer controller is the correct time sequencing of the individual spectrometer components, i.e. pump laser, probe lamp, monochromator, pump and probe

port shutters along with the digital storage oscilloscope. This task has been accomplished with the LP980 spectrometer; while maintaining maximum flexibility in measurement modes the user has complete control.

Measurement Modes

- Measurement setup
- Transient absorption
- Laser-induced fluorescence (LIF)
- Multiple spectral measurements
- Time-resolved absorption spectra (TRAS)
- Time-resolved emission spectra (TRES)
- Stopflow mode for use with optional stopped flow accessory
- MCS for Phosphorescence

Control Features

- Wavelength / slit control
- Filter wheel for second order light rejection
- Grating selection
- Pump laser flashlamp trigger
- Pump laser Q-switch trigger
- Probe source pulse current
- Pump and probe shutters
- Oscilloscope trigger
- Oscilloscope time base
- Oscilloscope voltage scale
- Signal offset
- Time shift / delay
- Optional temperature controlled sample holder
- Optional cryostat mounting
- Stopflow synchronisation
- Optional Energy Meters

Data Manipulation and Display

- ΔOD calculation (automatic and manual)
- Arithmetic (+, -, x, /)
- Scaling
- Normalise
- Baseline subtraction
- Data slicing – TRAS
- Data slicing – TRES
- Full data reconvolution using non-linear least square fitting routine
- 2D, 3D, Contour plotting and text

MEASUREMENT EXAMPLES

Transient Absorption and Photobleaching

In TA, the presence of the transient species can cause the sample to have either increased or decreased levels of absorption relative to the absorption of the ground state species (positive ΔOD and negative ΔOD respectively). While an increased absorption is associated with triplet-triplet or singlet-singlet transitions, a reduction in the measured optical density is associated with either ground state depletion or sample emission.

Generally these effects can be separated spectrally, or by means of their lifetimes. In some special cases (such as with the ruthenium bipyridine complex) separation by lifetimes is not possible.

Sample: Ruthenium bipyridine in water

Measurement Conditions: $\lambda_{\text{pump}} = 355 \text{ nm}$, $E_{\text{pump}} = 8 \text{ mJ}$, pulsed probe source, $\lambda_{\text{probe}} = 370 \text{ nm}$ (top picture), $\lambda_{\text{probe}} = 450 \text{ nm}$ (bottom picture), single shot.
Top: transient absorption at 370 nm. Bottom picture: photobleaching at 450 nm

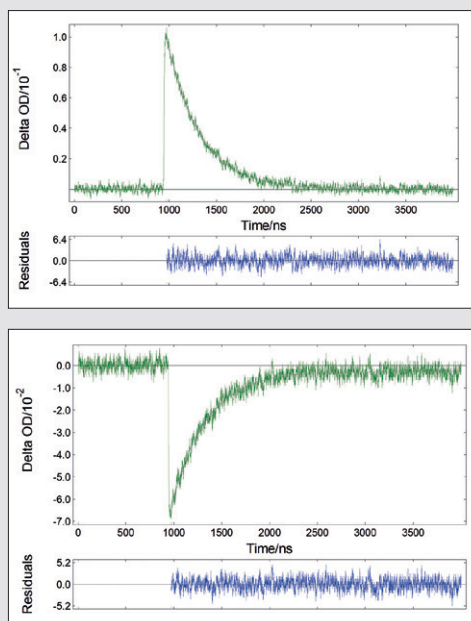

Triplet-Triplet Annihilation

Annihilation of excited states can take place if too many excited states are generated (due to high sample concentration or excessive pump energies) whose lifetimes are long compared to the diffusion times of the molecules. In this case diffusion controlled collisions become possible resulting in the de-activation of both molecules.

This example clearly shows the effect of laser energy on the transient dynamics. Annihilation is a non-exponential process but can be fitted with a series of exponential with the long lifetime representing the "true" excited state lifetime for the generated species.

Sample: Anthracene in cyclohexane, partially degassed

Measurement Conditions: $\lambda_{\text{pump}} = 355 \text{ nm}$, pulsed probe source, $\lambda_{\text{probe}} = 423 \text{ nm}$, three different laser excitation pulse energies: $E_{\text{pump}} = 50 \text{ mJ}$ (blue), $E_{\text{pump}} = 10 \text{ mJ}$ (red), $E_{\text{pump}} = 1 \text{ mJ}$ (green).

Bottom: measured change in optical density, Top: same data but scaled to same peak height. The green curve represents a single exponential decay with a lifetime of $\tau = 271 \mu\text{s}$

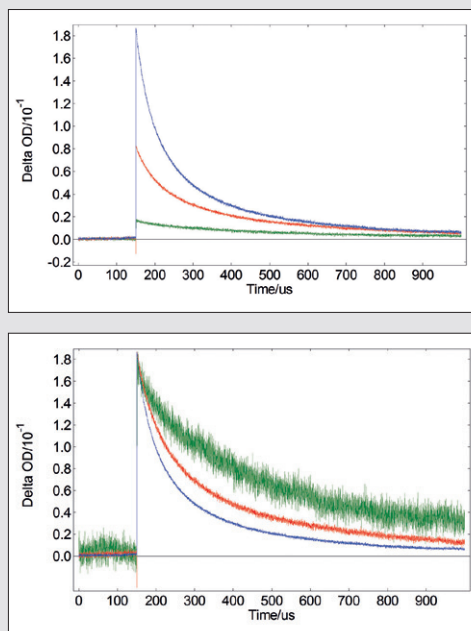

Singlet Oxygen Luminescence Decays

Singlet oxygen (1O_2) is an unstable species that emits luminescence at 1270 nm. Monitoring 1O_2 is challenging and requires systems capable of detecting single photons. The LP980 can be upgraded with photon counting electronics and an NIR-PMT detector for maximum sensitivity in the near-infrared range. NIR luminescence decays are acquired in Multi-Channel Scaling (MCS) mode as opposed to analogue detection.

Sample: 1O_2 luminescence from rose bengal in ethanol

Measurement Conditions: $\lambda_{\text{pump}} = 532 \text{ nm}$, $\lambda_{\text{em}} = 1270 \text{ nm}$, $\Delta\lambda_{\text{em}} = 20 \text{ nm}$, MCS resolution = 100 ns/channel

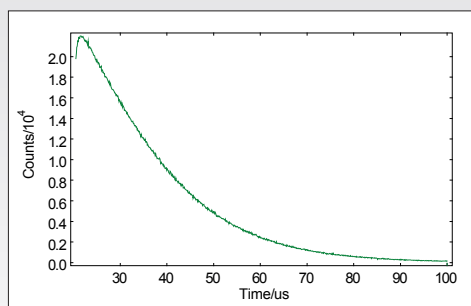

Spectrally Dependent Transient Kinetics

Time-resolved TA spectra can provide substantially more information than kinetic measurements alone. The measurement of benzophenone in cyclohexane shows two distinct absorption bands with maxima at 330 nm and 530 nm.

The delay characteristics (measured with a PMT) show different decay kinetics in each band. Spectral measurements (measured with an ICCD camera) reveal that the longer wavelength band shifts towards the near-infrared spectral range with time.

Sample: Benzophenone in cyclohexane

Measurement Conditions: Top: $\lambda_{\text{pump}} = 355$ nm, $E_{\text{pump}} = 8$ mJ, pulsed probe source, $\lambda_{\text{probe}} = 330$ nm (green), $\lambda_{\text{probe}} = 530$ nm (red), single shot. Bottom: $\lambda_{\text{pump}} = 355$ nm, $E_{\text{pump}} = 8$ mJ, pulsed probe source, spectral range 290 nm - 600 nm, gate width = 200 ns, delay (green) = 0 ns, delay (red) = 600 ns, delay (blue) = 1200 ns. Fit Results: at 330 nm: $t = 1100$ ns; at 530 nm: $t_1 = 151$ ns ($\phi_1 = 22\%$); $t_2 = 1126$ ns ($\phi_2 = 78\%$)

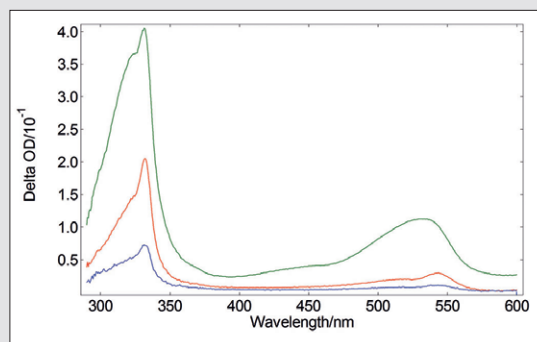
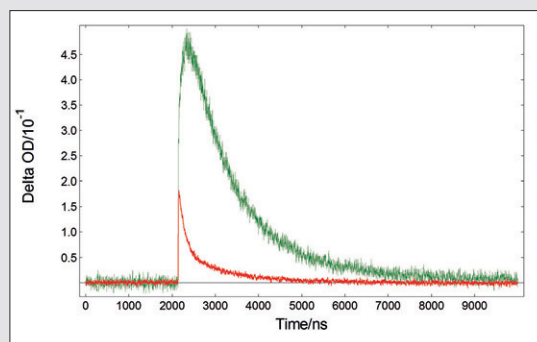

Data Slicing and Data Correction

Kinetic and spectral data sets can be viewed and analysed in various ways using the L900 software. Data slicing can be used to convert a set of kinetic decay data into spectral data and vice versa. Additionally, TA data can be corrected by making additional fluorescence measurements and then subtracting them in order to expose the true underlying TA behaviour.

L900 allows for automated fluorescence background subtraction, as well as probe subtraction. This is in addition to subtraction of the laser (pump) noise from the resulting spectra. These correction facilities ensure the most accurate data is represented. The automatic selection of high-pass filters in the monochromator filter wheel inhibits second-order grating effects.

Sample: Ruthenium bipyridine in water

Measurement Conditions: $\lambda_{\text{pump}} = 355$ nm, $E_{\text{pump}} = 9$ mJ, pulsed probe source, $\lambda_{\text{probe}} = 340$ nm - 700 nm in 10 nm steps using a PMT.

Top: data after spectral slicing without fluorescence correction, slicing 0 - 450 ns in 50 ns slices. Bottom: data after spectral slicing with fluorescence correction, slicing 0 - 450 ns in 50 ns slices.

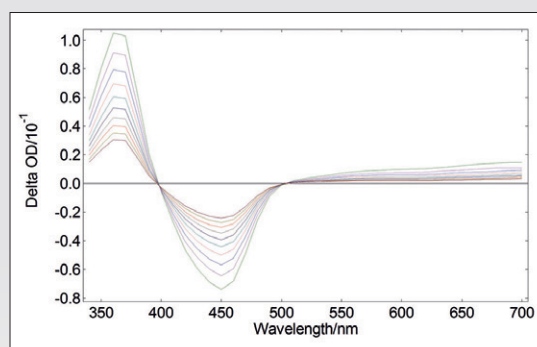
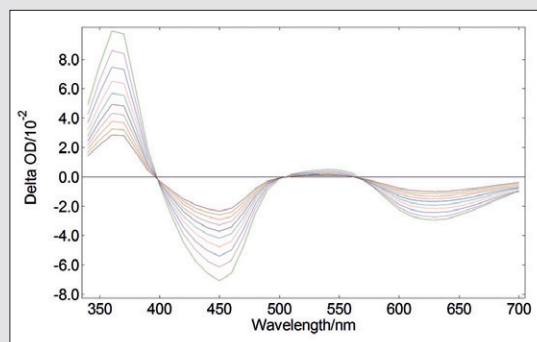

TIME-RESOLVED ABSORPTION SPECTRA

The LP980-K Spectrometer hardware is computer-controlled and enables the user to generate time-resolved absorption spectra in a two-fold process: firstly, a series of TA measurements over a pre-defined range of probe wavelengths is recorded, and, secondly, this data is sliced at desired time windows and delays from the laser pulse excitation.

By automatically scanning through the spectral range the probe background level can change. The changing background level does not have an effect on the value of the optical density, but it has an effect on the noise of the individual measurements. The LP980-K has the software option to either automatically reset the probe background offset or to correct for this changing background level.

Sample: Anthracene in cyclohexane, partially degassed

Measurement Conditions: $\lambda_{\text{pump}} = 355 \text{ nm}$, $E_{\text{pump}} = 5 \text{ mJ}$, pulsed probe source, $\lambda_{\text{probe}} = 390 \text{ nm} - 440 \text{ nm}$ in 1 nm steps using a PMT, spectral resolution = 1 nm , 16 averages per decay. Left: raw data obtained in kinetic mode, Bottom: data after spectral slicing.

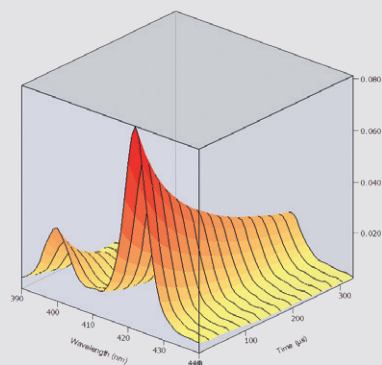
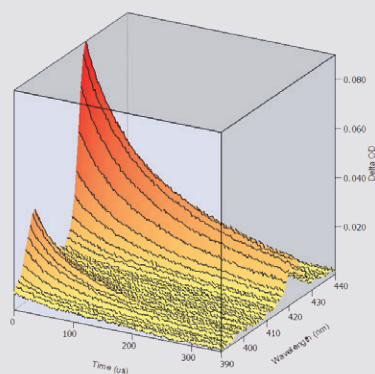

The spectrometer operating software can perform standard curve fitting of individual $\Delta\text{OD}(t)$ curves. The standard analysis is based on exponential decay models, taking into account the Gaussian statistics of the raw data.

For the advanced analysis of complex data sets an optional software package, FLASH is available. The advanced analysis software offers batch and global fitting of multiple $\Delta\text{OD}(t)$ curves and can also test the measurements for second order decay kinetic models.

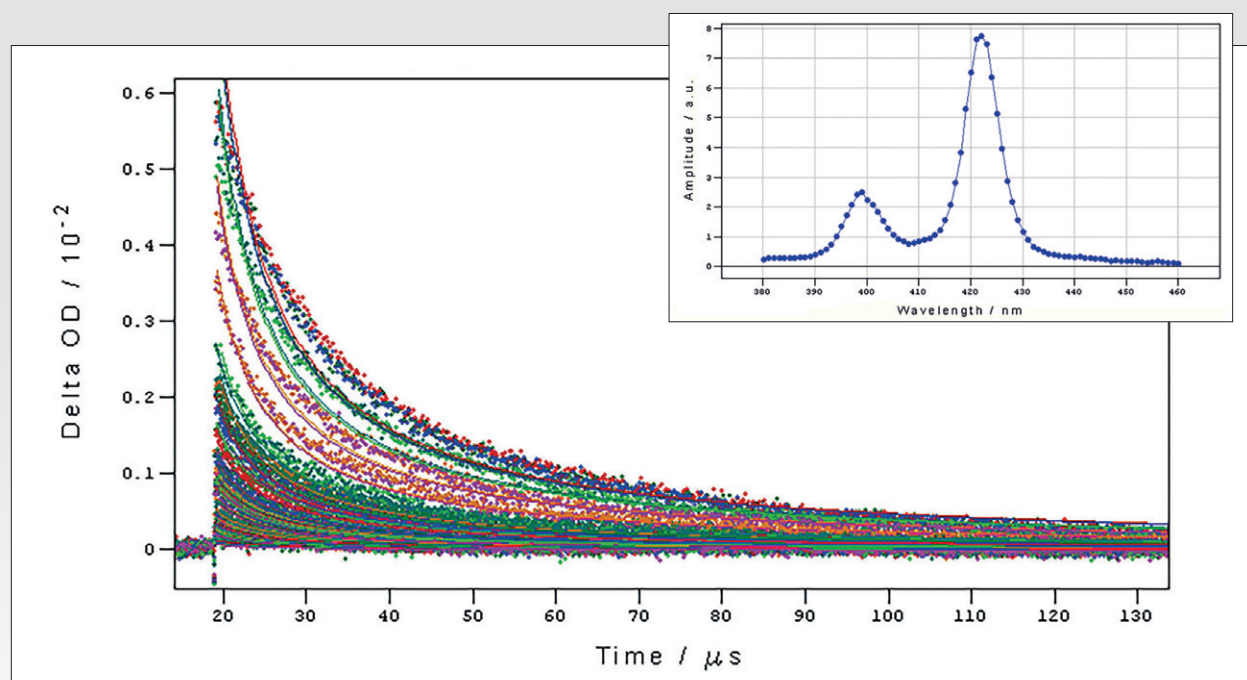

Raw data and fitted curves of the set of 80 time-resolved measurements of an anthracene example. Data were analysed with FLASH software (optional) using Global Analysis of a second order kinetic decay model, globally linking the rate constant. The result of the fit is a global second order rate constant of $1.8 \times 10^3 \text{ (M ms)}^{-1}$ and a wavelength dependence of the amplitude as shown in the insert.

LP980-K

TECHNICAL SPECIFICATIONS

SYSTEM

The LP980-K is a system for the measurement of laser-induced TA and emission decay kinetics with the ability to automatically generate temporally resolved TA and emission spectra.

Optional: Thin-film geometry, co-linear excitation, diffuse reflectance geometry, and fluorescence and phosphorescence lifetime measurements accessories are all available.

SENSITIVITY	Minimum ΔOD	0.002 (single shot, fast detector option) 0.0005 (single shot, slow detector option)
	TIME RESOLUTION	Instrument Response Function (FWHM) 5 ns (200 MHz acq. bandwidth, fast detector option)* 10 μs (slow detector option) 100 ns (InGaAs detector option)
* Faster IRFs are available with suitable oscilloscope(s) and laser(s). Contact Edinburgh Instruments for more information. Lasers with pulse width >6 ns will result in a broadened instrument response		
LASER EXCITATION SOURCE **	Single Wavelength	Flashlamp pumped Q-switched Nd:YAG laser, operating at 1064 nm, 532 nm, 355 nm or 266 nm**
	Tuneable	Dye Laser, tuneable range dependent on dye OPO, tuneable between 410 nm - 710 nm (signal). Idler and UV doubler options possible
** A fully tested laser system can be supplied by Edinburgh Instruments, or alternatively supplied by the customer		
PROBE SOURCE	Type	Pulsed / steady state xenon arc lamp, 150 W, ozone free
	Pulsed Operation	Rep. Rate - 10 Hz to single shot Pulse Current - Up to 100 A Pulse Duration - 0.2 ms – 6 ms
MONOCHROMATOR	Type	325 mm focal length, Czerny-Turner with Triple Grating Turret
	Filter Wheel	Integrated, automatic filter wheel for 2 nd order light removal
	Slits	5 μm - 10 mm (continuously adjustable), motorised
	Stray Light Rejection	1:10 ⁵
	Grating	Plane, ruled grating, 1800 grooves/mm, 500 nm blaze
	Dispersion	1.66 nm/mm
	Options	Gratings with 150 – 2400 grooves/mm, optimised from UV-NIR
	Mirror	Motorised to select detector
DETECTOR	Type	PMT with 5 stage dynode chain for high current linearity
	Spectral Range	200 nm – 870 nm
	Window Material	UV Glass
	Detector Impedance	50 Ω (amplified-fast detector, <3 ns rise time), 1 k Ω (slow detector, <100 μs rise time)
	Options	PMT-980 (200 nm - 980 nm) InGaAs detectors (900 nm - 2550 nm) NIR-PMT (up to 1650 nm)
DATA ACQUISITION	Oscilloscope	Fully remote-controlled by operating software, or manually controlled when offline
	Bandwidth	200 MHz as standard (350 MHz and 500 MHz optional)
	Sampling Rate	2.5 GS/s
	Interface	Ethernet
SOFTWARE	Operating System	Windows ®
	Data Manipulation	ΔOD calculation (with / without background correction), numerical fits by Marquardt-Levenberg algorithm, analysis of growth and decay kinetics, Time-Resolved Absorption Spectra

LASER PUMP SOURCE

In TA / Laser Flash Photolysis, transient species are generated using a short pulse, high peak power laser, known as the pump pulse. Suitable lasers include fixed wavelength lasers, particularly Nd:YAG lasers (fundamental wavelength 1064 nm) and their harmonics (at wavelengths 532 nm, 355 nm and 266 nm), or tuneable lasers, particularly optical parametric oscillators (OPOs). Other lasers sometimes used include nitrogen, excimer lasers and dye lasers.

The LP980 has been designed with the ultimate flexibility in mind. It can be supplied either as a turn-key, fully tested and performance guaranteed spectrometer, with integrated laser to suit individual needs and budget, or as a system with comprehensive trigger and command pulses to control virtually any commercially available laser.

Edinburgh Instruments have experience of integrating lasers from a wide variety of manufacturers including Continuum (Minilite and Surelite I and II Nd:YAG lasers, broadband or narrow band OPOs), Quantel (Q-Smart, Brio Nd:YAG with optional Rainbow OPO), OPOTEK (Opolette and Radiant OPOs), Ekspla (Lasers and OPO systems), Spectra Physics (Quanta-Ray Pro, Lab and Indi). OPOs by Continuum, OPOTEK and Ekspla can have their wavelengths tuned from within the L900 software.

Generally, flashlamp pumped Nd:YAG lasers have pulse widths in the range 5 ns - 7 ns. Pulse energies at the fundamental wavelength range typically from 50 mJ - 1000 mJ, dropping with each non-linear stage of harmonic generation to between 2 mJ - 20 mJ at 266 nm.

When pumped by the third harmonic of the Nd:YAG laser at 355 nm, OPOs provide broadly tuneable output from both signal and idler bands spanning the range from 410 nm – 2400 nm. Additional frequency doubling can extend the wavelength tuneability to the UV down to 210 nm. Type II OPOs are generally preferred as they do not suffer from a gap in tuneability around the degenerate wavelength at 710 nm although they characteristically have a slightly reduced pulse energy. With a pump pulse energy of 100 mJ at 355 nm OPOs have peak output energy of up to 35 mJ at 450 nm and several mJ over a wide tuning range. Edinburgh Instruments are happy to advise on the optimum laser for particular applications and budget.

PROBE SOURCE

In a conventional absorption spectrometer, the time averaged absorption of a sample is measured from the light level being attenuated whilst passing through the sample. In flash photolysis the temporal change of the attenuated light following laser excitation is measured. As these changes often occur in the nanosecond time range, the available light level in the probe beam may be too low for an acceptable signal to noise ratio. In order to overcome this and to provide sufficient probe light levels, a pulsed probe source is used.

The best way of supplying a broad band, stable light pulse with a flat time profile is by using a xenon arc lamp operated by adding a "super current pulse" to the low current simmer supply. A pulsed xenon lamp exhibits a significant increase in the emitted photon flux during the period of the pulse, compared with the photon flux from the same lamp in steady-state operation over the equivalent time period. During pulsed operation, the colour temperature of the arc is dramatically increased over its steady state equivalent and as a result, the emission profile is shifted towards the UV and the spectrum is less structured.

The LP980 contains a built-in lamp pulser with particular emphasis on pulse flatness, reproducibility and minimum ripple.

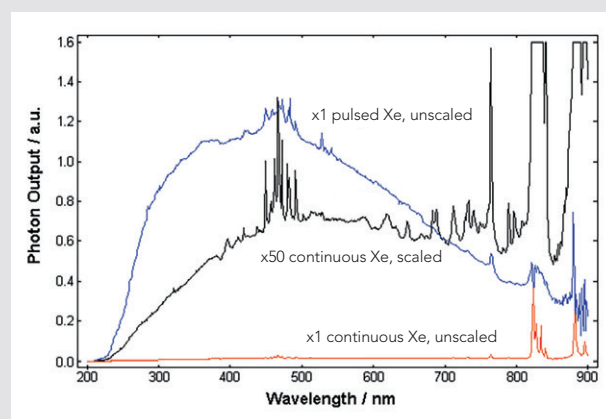

Xenon arc lamp emission spectrum monitored over a 3 ms period. Lamp in continuous operation (red curve - unscaled; black curve - scaled) and in pulsed operation with a current pulse of 150 A (blue curve). Spectra were measured using an ozone-free Xenon bulb and are corrected for the responsivity of the detection system.

LP980-SYSTEM OVERVIEW

TRANSIENT ABSORPTION SPECTROMETER



MONOCHROMATOR / SPECTROGRAPH

The LP980 spectrometer has a three grating turret monochromator/spectrograph which gives maximum flexibility in wavelength coverage and spectral resolution, for both the UV-VIS and near IR spectral ranges.

The monochromator/spectrograph has a symmetric Czerny-Turner optical configuration with a focal length of 325 mm and a constant aperture of F/4.1.

For kinetic (K) mode, UV-VIS operation, the system is fitted with a standard 1800 g/mm grating. It has a linear dispersion of 1.66 nm/mm, blazed at 500 nm, and a wavelength coverage from 200 nm - 900 nm. For near IR operation the standard grating has 600 g/mm, with a blaze wavelength of 1 μ m, covering the spectral range from 600 nm - 2.7 μ m.

For time-gated measurement applications in the kinetic/spectral (KS) mode, the standard grating has 150 g/mm and is blazed at 500 nm. It offers a spectral range of 540 nm with the standard 25 mm long detector array. Other grating options with wavelength coverage of 270 nm and 135 nm are available upon request.

A combination of up to three different gratings can be fitted to the grating turret. The selection of the grating type and the requested spectral position is made by a micro-stepping drive controlled from the system software. This gives unparalleled accuracy and reproducibility in the spectral performance of the system.

A unique feature of the monochromator is the computer-controlled beam steering mirror at the exit port, allowing rapid selection of detectors (e.g. photomultiplier and InGaAs detector or single element and array detector) without the need for mechanical or optical adjustment.

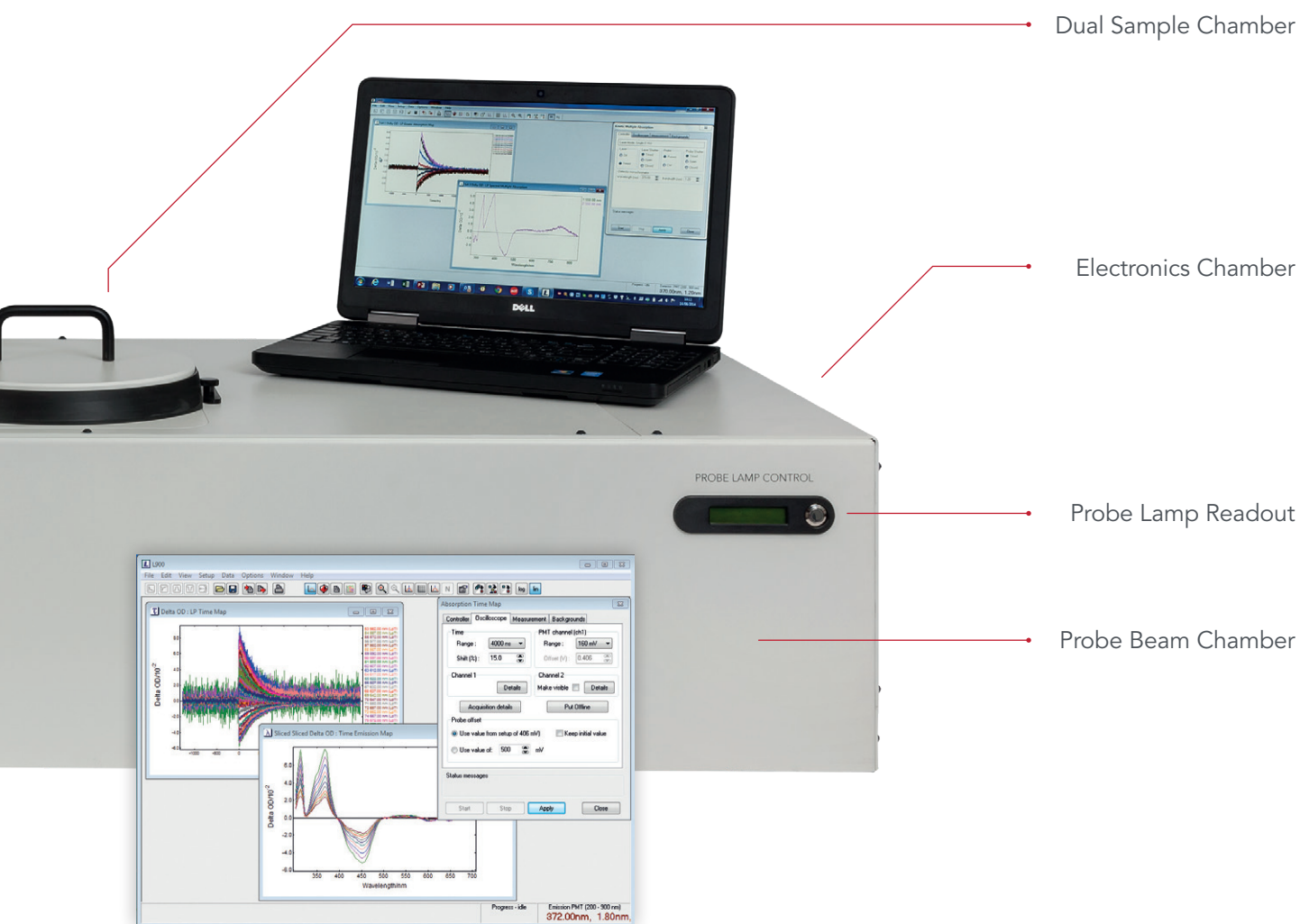

Dual Sample Chamber

Electronics Chamber

Probe Lamp Readout

Probe Beam Chamber

DETECTORS

Kinetic Mode (K)

The LP980 in its kinetic mode is supplied, as standard, with a red sensitive PMT which covers the spectral range from 200 nm - 870 nm. Optional detectors are also available with extended spectral range up to 980 nm or 1010 nm.

For TA and emission measurements further into the near infrared (NIR), InGaAs photodiodes can be used with coverage up to 2550 nm. There are 3 different InGaAs detectors to choose from. These cover spectral ranges up to 1650 nm, 2050 nm and 2550 nm.

The LP980 employs NIR-PMTs to make Laser-Induced Fluorescence (LIF) measurements using the Multi-Channel Scaling (MCS) photon counting technique. This is used for example in singlet oxygen analysis.

Spectral Mode (S)

Spectral mode allows the user to study the full time-gated transient spectra within one flash of the pump laser. This is especially useful when studying samples that are not photostable.

The LP980 in spectral mode utilises a gated ICCD camera optimised for spectroscopy applications. The ICCD is gated so that transient spectra from a few nanoseconds to seconds can be recorded.

There are various ICCD options available based on spectral coverage and minimum gate widths. To discuss which camera is best suited to your requirements please contact us directly.

DUAL SAMPLE CHAMBER AND BEAM GEOMETRY

Transient Absorption (standard)

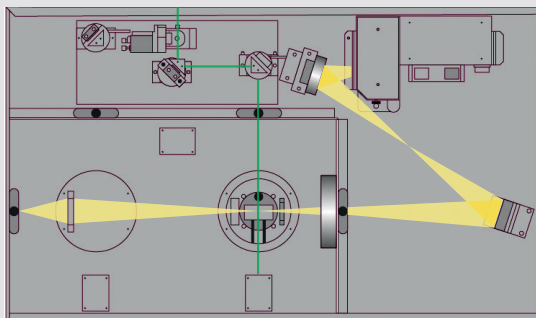

Laser-Induced Fluorescence (standard)

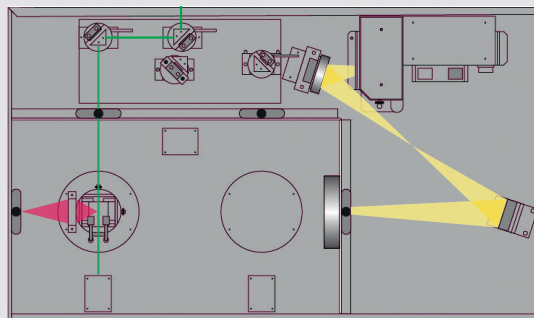

Quasi-Co Linear (optional)

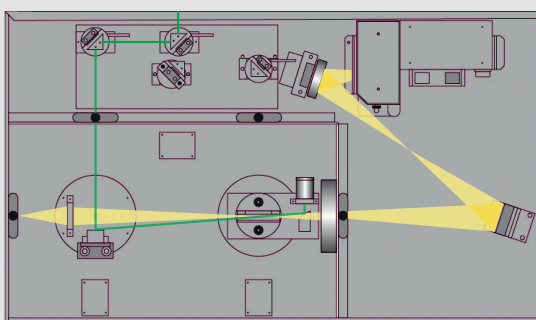

Diffuse Reflectance (optional)

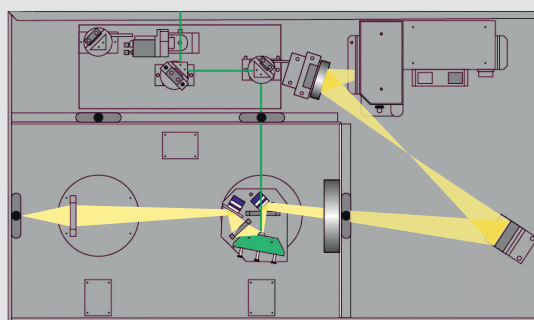

ACCESSORIES

Stopped Flow Accessory

A rapid kinetic accessory for multi-mixing capabilities is available to allow stopped flow analysis. It comprises a sample handling unit fitted with three 1.0 ml drive syringes, 600 mm long umbilical, software controlled drive, and 12.5 mm square mixing/observation cuvette.

Film Sample Holder

Vertically mounted sample holder for transparent thin-film and slide samples at 45 degrees, with rotational and X-Y movement control.



Laser Energy Meters

This accessory measures the energy of each excitation pulse and the energy transmitted by the sample. Energy meters are controlled from the software and calibrated so that the energy absorbed by the sample can be monitored. Energy Meters are sensitive in the range of 190 nm - 12 μ m.

TE-Cooled Sample Holders

A temperature-controlled cuvette holder with range of -10°C- +105°C can be placed in the sample chamber. The temperature is fully controlled from the L900 software with a precision of $\pm 0.02^\circ\text{C}$. Magnetic stirring is included, and extended versions (-50°C to +105°C) are available.

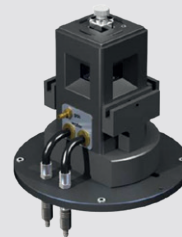

Cryostat

Liquid nitrogen cryostats enable temperature-controlled measurements from 77 K to 300 K (an extended version up to 500 K is available). The cryostat is provided with an adapter to fit into the standard sample chamber and the temperature is fully controlled by the L900 software. A liquid nitrogen dewar sample holder is available as a low-cost option for measurements at 77 K.

LP980-KS

TECHNICAL SPECIFICATIONS

The LP980-KS is a combined system for the measurement of laser-induced TA and emission decay kinetics AND spectra with the ability to automatically convert and fully analyse the kinetic and spectral information. Wavelength specific kinetic measurements are made using a PMT and oscilloscope, while time-gated spectral measurements are obtained using an image-intensified CCD camera.

The LP980-KS technical specification includes all specifications from the LP980-K plus the additional:

SENSITIVITY	Minimum ΔOD	0.0005 (single shot) - ICCD camera
TIME RESOLUTION	Minimum Gate Width (FWHM)	7 ns* (3 ns, ultrafast option available)
	* Lasers with pulse width >6 ns will result in a broadened instrument response	
MONOCHROMATOR / SPECTROGRAPH	Type	325 mm focal length, Czerny-Turner with Triple Grating Turret
	Filter Wheel	Integrated, automatic filter wheel for 2 nd order light removal
	Slits	5 μm - 10 mm (continuously adjustable), motorised
	Grating	K-mode grating <u>AND</u> plane, ruled grating, 150 grooves/mm, 500 nm blaze
	Dispersion	19.9 nm/mm
	Spectral Coverage	520 nm (active horizontal ICCD dimension: 25 mm)
	Spectral Resolution	0.52 nm (spectral coverage / 960 pixels)
	Options	Gratings with 300 grooves/mm or 270 nm coverage and 0.28 nm resolution
	Mirror	Motorised to select detector
DETECTOR LP980-K PMT detector plus:	Type	Image intensified CCD camera
	Spectral Range	200 nm – 850 nm
	Min. Optical Gate Width	7 ns (FWHM)
	Active Pixels	960 x 256
	Active Area	25 mm x 6.7 mm
	Cooling	-20°C (-30°C with additional water circulation)
	Options	3 ns min. optical gate width 300 nm - 930 nm spectral range
DATA ACQUISITION	ICCD	Fully remote controlled by operating software
	Fast Vertical Binning	16-bit data resolution
	Image	24-bit data resolution
SOFTWARE	Operating System	Windows ®
	Data Manipulation	ΔOD calculation, mathematical, smoothing, automatic kinetic spectra acquisition, transformation into kinetics by data slicing, 2D, 3D graphics, contour plotting

OVERVIEW

The generation of spectra in kinetic mode by successive measurements at different wavelengths requires many excitation flashes. This can sometimes be problematic because of sample photodegradation and instability. This is true in particular when highly spectrally resolved results (with small wavelength steps) are anticipated.

An efficient method to overcome these issues is to use the LP980-KS – the kinetic and spectral mode version of the LP980 laser flash photolysis spectrometer.

The LP980-KS has an array detector fitted to the spectrograph exit port to measure a full range of wavelengths simultaneously. By means of a swing mirror and a slit at the second exit port, a kinetic detector can still be fitted to the spectrometer.

The array detector is a CCD camera with an integrated gated image intensifier (ICCD). The device exhibits a high sensitivity and allows time-resolved spectra to be measured in a window as narrow as 3 ns.

OPERATIONAL EXAMPLE

The continuous spectral output of the xenon lamp forms the background light level for time-gated spectra. The spectral characteristics of this background light is determined by many factors, such as the xenon lamp output, monochromator efficiency, ICCD spectral responsivity and sample ground state absorption characteristics.

After laser excitation, the continuous background will be modified according to the transient features of the sample, depending on image intensifier gate width and delay.

The optical density change is calculated from the differences between background and measurement after sample excitation.

For comparison, the bottom figure demonstrates the ground state absorption and emission of the same $[\text{Ru}(\text{bpy})_3]^{2+}$ sample. The effect of the ground state and excited state phenomena on the ΔOD spectra can clearly be seen.

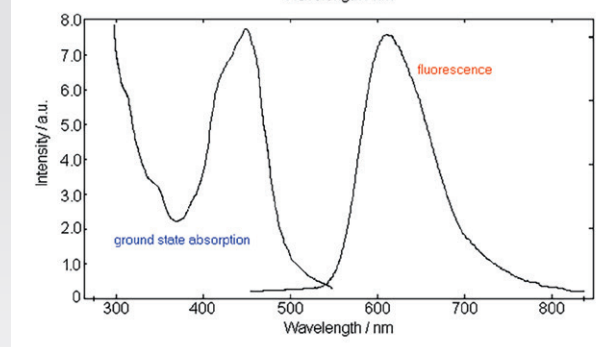
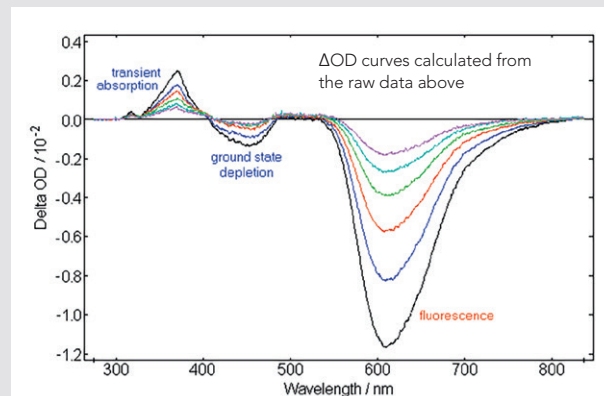
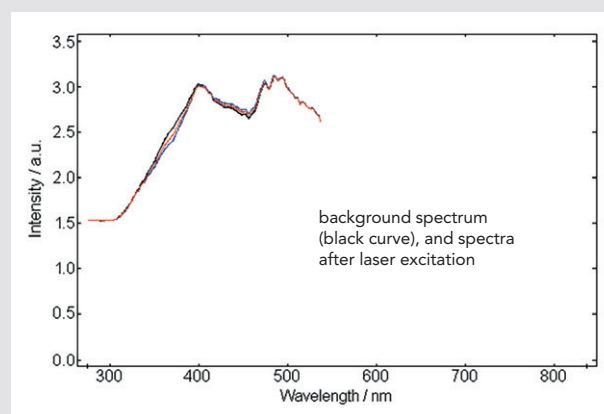

SIGNAL DETECTION AND DATA ACQUISITION

The LP980-KS uses an externally triggered, gated ICCD camera optimised for spectroscopy applications. The ICCD detector has the high sensitivity of a PMT as well as nanosecond time resolution. It combines the highest quality scientific grade CCD array detector with image intensifier, gating and delay circuits, and CCD cooling fully integrated into one compact detector.

The CCD multi-channel detector has a characteristic high dynamic range and an ultra-low readout noise.

The gain of the image intensifier is user adjusted so the sensitivity of the detector can be set to the best level for the measurement. At low gain the sensitivity is comparable to that of a normal CCD detector. When operated at high gain the ICCD detector can detect single photons.

The ICCD camera is a software-controlled device with its hardware / software interface located in the spectrometer control computer. This permits all image intensifier parameters, CCD parameters, and data transfer operations to be fully controlled by the L900 spectrometer software.



Andor iSTAR

DETECTION LIMIT

The information from the CCD detector can be read with a rate of $1 \mu\text{s}/\text{pixel}$ for fast results or with read-out rates of up to $32 \mu\text{s}/\text{pixel}$ for the lowest possible readout noise. In addition, the CCD may be cooled down to -25°C (air cooled) or -35°C (with chiller) for further noise reduction and minimal baseline drift when measurements are made over extended periods.

The LP980-KS can operate the ICCD in either fast vertical binning mode, where the information contained in the 256 vertical pixels are accumulated on the CCD before being transferred to the computer, or in image mode, where all pixels are read individually and the information of the vertical columns is averaged in the computer memory. For laser flash photolysis experiments the latter mode is desired as it improves the dynamic range, at the cost of a slower experimental repetition rate.

The detection limit of the ICCD array detector is $\Delta\text{OD} = 0.0005$ for a single shot measurement. It can be further enhanced by signal averaging.

Sample: Erythrosin B in Water

Measurement Conditions: $\lambda_{\text{pump}} = 532 \text{ nm}$, $E_{\text{pump}} = 1 \text{ mJ}$, pulsed probe source, $10 \mu\text{s}$ gate width, $1 \mu\text{s}$ gate delay

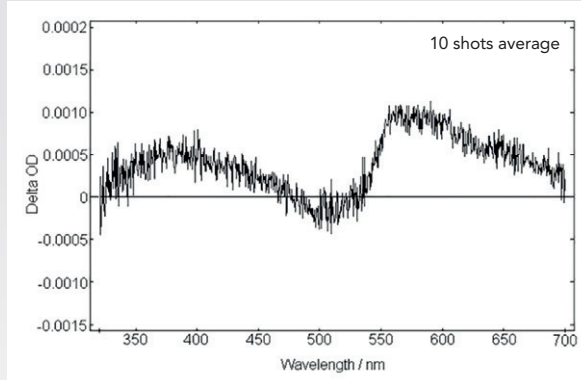
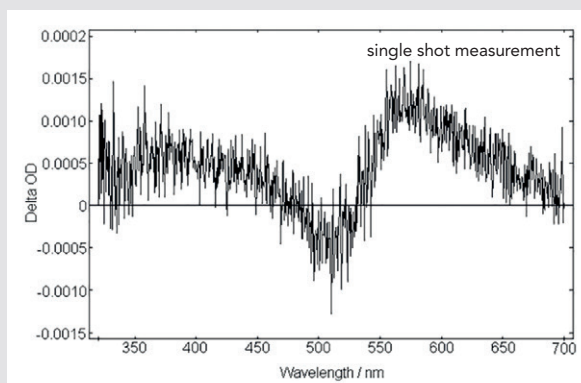

Demonstration of the detection limit and of the Signal-to-Noise improvement by signal averaging

SOFTWARE

The L900 software package controls both the LP980-K, kinetic mode operation as well as the LP980-KS, kinetic and spectral mode operation. This ensures full compatibility between the two modes as well as a user-friendly software environment for systems able to operate in either mode. The user can view pixel bitmaps of the CCD image to assess the quality of the image at the ICCD photocathode. This is particularly useful for setup and optimisation purposes prior to measurement sequences.

For standard measurements, 2D images of the raw data and the resulting optical densities are the preferred plot options. Comprehensive spectral calibration features are available and automatic software subtraction of camera dark noise is provided.

A variety of different spectral measurement and correction options can be made. For example, with the probe shutter permanently closed, normal time-resolved emission spectra are taken. If a measurement sequence is made with a fixed gain and fixed gate width, but with incremental increase of the gate delay, a map of time-resolved spectra is automatically generated. These can be sliced to produce kinetic decays at a given wavelength.

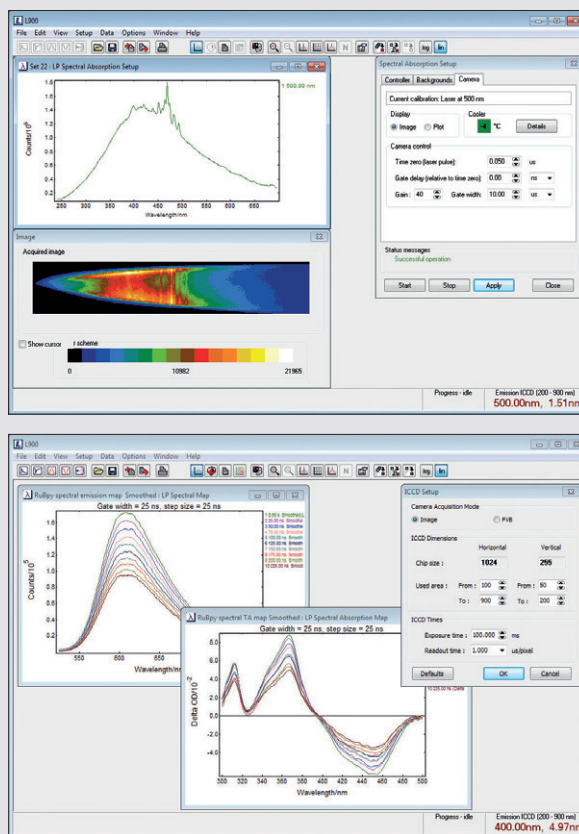

SOFTWARE FUNCTIONALITY

While maintaining full flexibility for users who want to use the ICCD in specific setup modes (like restriction of image size, modification of data transfer rates, use of fast vertical binning mode), particular attention has been paid to make the software user friendly for scientists who

have their minds focussed entirely on the sample and TA results. It will take a newcomer only a few minutes to become familiar with the requirements for standard measurements in the spectral mode.

Measurement Modes

- Measurement setup
- Transient absorption
- Laser-induced fluorescence (LIF)
- Multiple spectral measurements
- Time-gated absorption maps
- Time-gated emission maps

Control Features

- Wavelength / slit control
- Grating selection
- Spectrograph port selection
- Pump laser flashlamp trigger
- Pump laser Q-switch trigger
- Probe source pulse current
- Pump and probe shutters
- ICCD gain
- ICCD gate delay
- ICCD gate width
- ICCD temperature
- Cryostat
- Temperature-controlled cuvette holder
- Optional Energy Meters

Data Manipulation and Display

- Δ OD calculation
- Arithmetic (+, -, x, /, append)
- Scaling
- Normalise
- Baseline subtraction
- Smoothing
- Data slicing
- 2D, 3D, Contour plotting and text

MEASUREMENT EXAMPLES

Time-Gated Transient Absorption Spectra and corresponding Fluorescence

Anthracene has distinct spectral bands when viewed in the nanosecond and microsecond timescales, as the features of fluorescence and TA can be seen in the two graphs opposite.

- (immediately after laser pulse): fluorescence superimposed on TA. The large, but fast decaying, fluorescence alone can be seen on the plot on the bottom
- (200 μ s after laser pulse): the fluorescence has gone and the TA bands become more distinct
- (400 μ s after laser pulse): the TA decay continues

Sample (top): Anthracene in cyclohexane, partially degassed

Measurement Conditions: TA: $\lambda_{\text{pump}} = 355$ nm, $E_{\text{pump}} = 10$ mJ, pulsed probe source, spectral range 300 nm - 500 nm, gate width = 1 ms

Sample (bottom): Anthracene in cyclohexane, partially degassed

Measurement Conditions: LIF: $\lambda_{\text{pump}} = 355$ nm, $E_{\text{pump}} = 10$ mJ, spectral range 300 nm - 500 nm, gate width = 50 ns

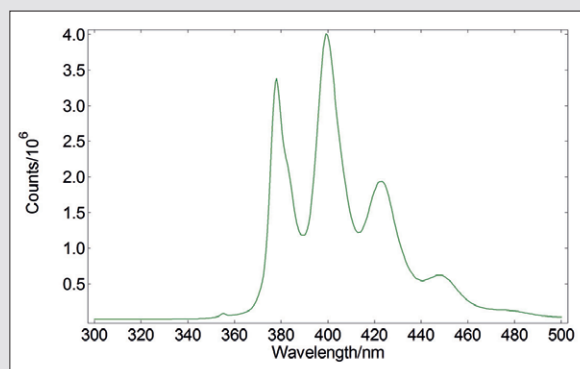
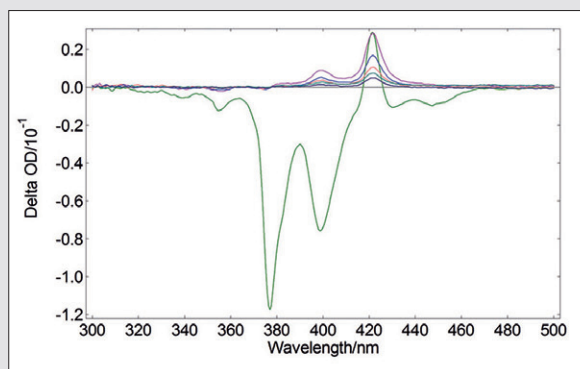

Time-Gated Laser-Induced Fluorescence Spectra

The LP980 has an enhanced capability that no other TA spectrometer on the market can do. It can also capture laser-induced fluorescence spectra in the ultraviolet, visible and near-infrared spectral ranges. In addition to this, the spectra can be time-resolved.

The graph on the right shows ruthenium bipyridine laser-induced time-resolved fluorescence spectra.

- immediately after laser pulse
- 100 ns after laser pulse
- 200 ns after laser pulse
- 300 ns after laser pulse
- 400 ns after laser pulse

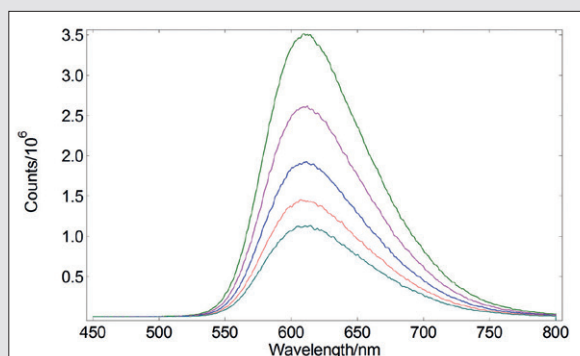

Sample: Ruthenium Bipyridine in water

Measurement Conditions: (LIF) $\lambda_{\text{pump}} = 450$ nm, $E_{\text{pump}} = 10$ mJ, spectral range 450 nm - 800 nm, gate width = 100 ns

EDINBURGH INSTRUMENTS

2 Bain Square,
Kirkton Campus,
Livingston, EH54 7DQ
United Kingdom

Tel: +44 (0)1506 425 300
Fax: +44 (0)1506 425 320

sales@edinst.com

U.S. SUPPORT

Tel: +1 800 323 6115
Fax: +44 (0)1506 425 320

ussales@edinst.com



Customer support is
available worldwide

edinst.com

Registered in England and Wales No: 962331 VAT No:GB 271 7379 37
©Edinburgh Instruments Ltd 2018

F/08.2018

