

PRIOR[®]
S c i e n t i f i c

AUTOMATION GUIDE
Nikon microscopes

Introduction

We designed this brochure to provide in-depth information about the range of equipment compatible with Nikon microscopes. It covers the majority of current Nikon microscopes, as well as some earlier generation products of the same type.

Please do not hesitate to contact Prior Scientific if your microscope does not appear on this list as some of the products shown here may still be compatible.

More information about our products can be found by contacting a Prior representative, emailing inquiries@prior.com or by visiting prior.com.

We also have an extensive collection of datasheets freely available on our website or contacting Prior Scientific.

While every effort has been made to ensure that the products listed are compatible with each microscope, specific add-ons or configurations may render some products incompatible. We recommend contacting a Prior Scientific sales manager before ordering.

Please note that the parts may vary in availability and part numbers and specifications may change without warning. Whilst we have attempted to verify that the information here is accurate, we cannot guarantee that it is completely up to date and error free; thus we suggest contacting Prior before ordering in order to ensure that all equipment will be compatible with your microscope and suitable for your application. The microscopes featured here are for illustrative purposes only. All intellectual property relating to these microscopes, including patents and trademarks, remain the property of their respective owners. Olympus is a registered trademark of Olympus Corporation. ProScan®, OptiScan® and ZDeck® and the Prior Scientific logo are registered trademarks of Prior Scientific Ltd.

Contents

Introduction.....	2	Nikon TE2000 configuration guide	26	Nikon Ni (focusing nosepiece) configuration guide	50	Illumination	70
Contents.....	4	Motorized XY stages and sample holders.....	26	Motorized XY stages and sample holders.....	50	Excitation path.....	70
ProScan III controller configuration guide	6	Nanopositioning stages and sample holders	26	Zdeck stages and sample holders.....	50		
Nikon Ti2 configuration chart.....	8	Objective positioners and adaptors.....	27	Nanopositioning stages and sample holders	51	Nikon SMZ18/25 configuration chart	72
		Motorized focus	27	Objective positioners and adaptors.....	51		
Nikon Ti2 configuration guide	10	Illumination	27	Motorized focus	51	Nikon SMZ18/25 configuration guide	74
Motorized XY stages and sample holders.....	10	Excitation path.....	28	Illumination	52	Motorized XY stages and sample holders.....	74
Large format XY stages and sample holders.....	10	Emission path	28	Excitation path.....	52	Flat top XY motorized stages and sample holders	74
Nanopositioning stages and sample holders	11					Large format XY motorized stages and sample holders	75
Objective positioners and adaptors.....	11	Nikon Ni configuration chart	30			Motorized focus	75
Motorized focus	11			Nikon LV100/LV150 configuration chart	54		
Autofocus	12	Nikon Ni configuration guide	32	Motorized XY stages and sample holders.....	56	Nikon MA200 configuration chart	76
Illumination	12	Motorized XY stages and sample holders.....	32	Large Format XY motorized stages and sample holders	56		
Excitation path.....	12	Large Format XY motorized stages and sample holders...	32	Flat top XY motorized stages and sample holders	57	Nikon MA200 configuration guide	77
Emission path	13	Flat top XY motorized stages and sample holders	33	Large format wafer scanning		Motorized XY stages and sample holders.....	77
Deck inserts.....	13	Objective positioners and adaptors.....	33	XY stages and sample holders	57	Motorized focus	77
Well plate loader	13	Motorized focus	34	Objective positioners and adaptors.....	58	Illumination	78
		Autofocus	34	Motorized focus	58	Excitation path.....	78
		Illumination	34	Autofocus	58		
		Excitation path.....	35	Illumination	59		
				Excitation path.....	59		
Nikon Ti configuration chart.....	14	Nikon Ci configuration chart.....	36				
				Nikon L200 configuration chart.....	60		
Nikon Ti configuration guide	16	Nikon Ci configuration guide	38	Motorized XY stages and sample holders.....	62		
Motorized XY stages and sample holders.....	16	Motorized XY stages and sample holders.....	38	Motorised XY stages and sample holders			
Large format XY stages and sample holders.....	16	Large format XY motorized stages and sample holders ...	38	for up to 8 inch diameter wafers	62		
Nanopositioning stages and sample holders	17	Flat top XY motorized stages and sample holders	39	Objective positioners and adaptors.....	63		
Objective positioners and adaptors.....	17	Objective positioners and adaptors.....	39	Motorized focus	63		
Motorized focus	17	Motorized focus	40	Autofocus	64		
Autofocus	18	Autofocus	40	Illumination	64		
Illumination	18	Illumination	40	Excitation path.....	65		
Excitation path.....	18	Excitation path.....	41				
Emission path	19			Nikon L300 configuration chart.....	66		
Deck inserts.....	19	Nikon FN1 configuration chart.....	42	Motorized XY stages and sample holders.....	68		
Well plate loader	19	Motorized XY stages and sample holders.....	44	Motorised XY stages and sample holders			
		Zdeck stages and sample holders.....	44	for up to 6 inch diameter wafers	68		
		Nanopositioning stages and sample holders	45	Motorised XY stages and sample holders			
		Objective positioners	45	for up to 8 inch diameter wafers	68		
		Motorized focus	45	Objective positioners and adaptors.....	69		
		Illumination	46	Motorized focus	69		
		Excitation path.....	46	Autofocus	69		
Nikon Ts2R configuration chart	20	Nikon FN1 configuration guide.....	44				
		Motorized XY stages and sample holders.....	44				
Nikon Ts2R configuration guide.....	22	Motorized XY stages and sample holders.....	44				
Motorized XY stages and sample holders.....	22	Zdeck stages and sample holders.....	44				
Large format XY stages and sample holders.....	22	Nanopositioning stages and sample holders	45				
Nanopositioning stages and sample holders	23	Objective positioners	45				
Objective positioners and adaptors.....	23	Motorized focus	45				
Motorized focus	23	Illumination	46				
		Excitation path.....	46				
Nikon TE2000 configuration chart.....	24	Nikon Ni (focusing nosepiece) configuration chart	48				

ProScan III controller configuration guide

The ProScan III controller range can be used to control a wide range of Prior Scientific's microscope automation equipment. Choosing the correct controller is critical to ensuring that all of your chosen components can be used effectively. After selecting the hardware for your microscope, use the following guide to identify the correct controller. Systems which already utilize a ProScan III controller but cannot control some pieces of hardware may be upgraded using an ancillary box, depending on revision status.

Stages: Determine if your stage is a linear or stepper motor stage as these controllers are not interchangeable. All ProScan III controllers which can control stages also support encoders.

Focus: All ProScan III controllers which can control stepper motor focus systems also support encoders. Nanopositioning products in this configuration guide are supplied with their own controller, which can be operated through the ProScan III if desired. If using a H101E1F, H101E2F or encoded Z-deck with an encoded focus system please contact Prior Scientific before placing your order.

Filter wheels: For systems without a motorized stage or focus use the V31F controller. Please note that it may not be possible to control more than 3 filter wheels with some third party software.

Shutters: For systems without a motorized stage or focus use the V31F controller. Please note that it may not be possible to control more than 3 shutters with some third party software.

Metal Halide Illuminators: Third party software can control the L200S directly without the need for a controller. Alternatively, the built in shutter of the L200S and L220S can be controlled through any ProScan III controller which has a shutter port. The lamp on/off and shutter open/closed trigger ports can also be controlled through any controller with a trigger board. The L200 and L220 are completely standalone and does not require a ProScan III controller.

LED Illuminators: LDB103 LED illuminators can be controlled through any ProScan III controller with a shutter port. If not ordering any other Prior components, consider the LDB102, which is a standalone illuminator which does not require a ProScan III controller.

Autofocus: The PF850 autofocus is supplied with a standalone controller. No ProScan III controller is required.

For motorized microscope upgrades on a lower budget, please contact Prior Scientific to learn more about our OptiScan product range.

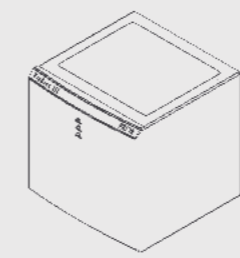
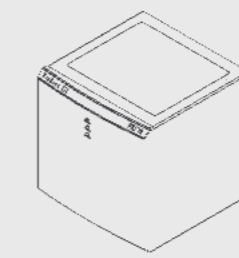
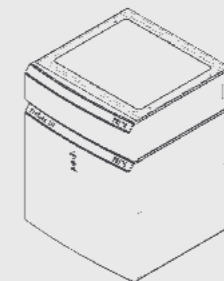
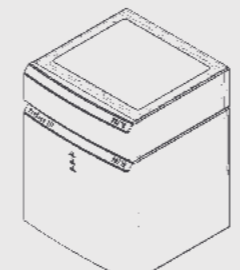
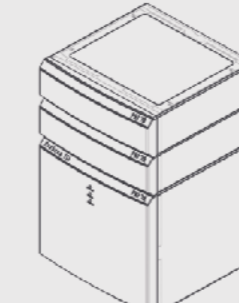
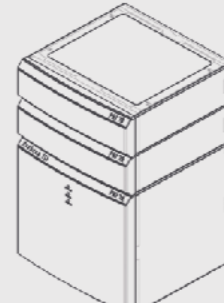
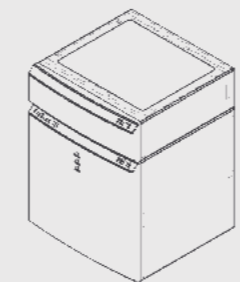
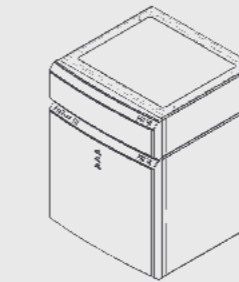
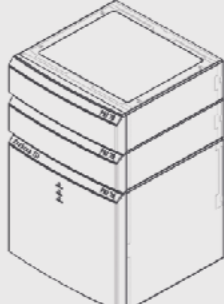
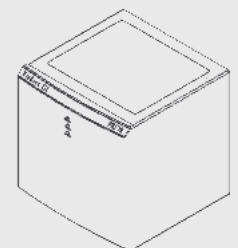
<p>V31F</p>  <ul style="list-style-type: none"> • 3x filter wheels • 3x shutters • L200S • LDB103 	<p>V31XYZE</p>  <ul style="list-style-type: none"> • XY stepper stage • Z axis (excl. piezo) • Encoders 	<p>V31XYZET</p>  <ul style="list-style-type: none"> • XY stepper stage • Z axis (excl. piezo) • Encoders • Trigger board 	
<p>V31XYZEF</p>  <ul style="list-style-type: none"> • XY stepper stage • Z axis (excl. piezo) • Encoders • 3x filter wheels • 3x shutters • L200S • LDB103 	<p>V31XYZEFT</p>  <ul style="list-style-type: none"> • XY stepper stage • Z axis (excl. piezo) • Encoders • 3x filter wheels • 3x shutters • L200S • LDB103 • Trigger board 	<p>V31XYZEF2</p>  <ul style="list-style-type: none"> • XY stage • Z axis (excl. piezo) • Encoders • 6x filter wheels • 6x shutters • L200S • LDB103 	
<p>VLD31XYZFG</p>  <ul style="list-style-type: none"> • XY linear stage • Z axis (excl. piezo) • Encoders • 3x filter wheels • 3x shutters • L200S • LDB103 	<p>VLD31XYZTG</p>  <ul style="list-style-type: none"> • XY linear stage • Z axis (excl. piezo) • Encoders • Trigger board 	<p>VLD31XYZFTG</p>  <ul style="list-style-type: none"> • XY linear stage • Z axis (excl. piezo) • Encoders • 3x filter wheels • 3x shutters • L200S • LDB103 • Trigger board 	<p>VLD31XYZG</p>  <ul style="list-style-type: none"> • XY stage • Z axis (excl. piezo) • Encoders

Nikon Ti2 configuration chart

See the following pages for more product information.

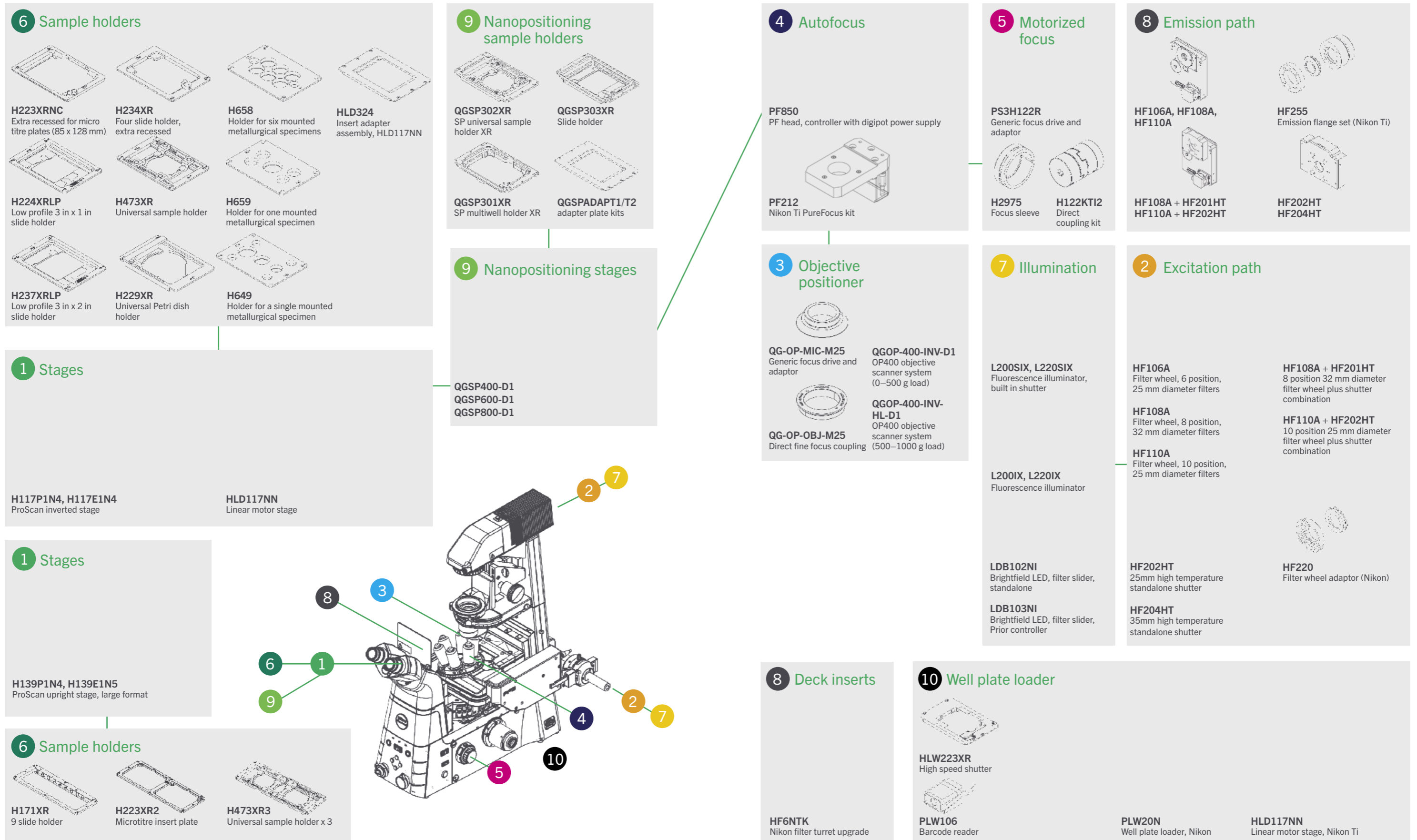

Nikon Ti2 configuration guide

The Nikon Ti2 has three variants; Ti2-U (non-motorized), Ti2-A (non-motorized, microscope status detection), and Ti2-E (fully motorized). Prior Scientific can supply motorized upgrades for all product types to the Ti2-U and Ti2-A. The Ti2-E can be upgraded with Prior Scientific stages, Queensgate nanopositioning stages, objective positioners, and autofocus, which enhance the capabilities of this fully motorized system.

Motorized XY stages and sample holders

All the sample holders listed are compatible with the H117P1N4, H117E1N4, and HLD117NN. The HLD324 is required for Prior sample holders when using the HLD117NN. Nikon sample holders can be fitted to the HLD117NN only. At least one sample holder is required. The H139P1N4 and H139E1N5 are available for customers wanted to expand their analysis to a pair of well plates or Petri dishes or up to nine slides. Sample holders associated with the H139 stage range must be used. The H139E1N5 is fitted with 50 nm encoders. The Ti2-E features a motorized stage, but the HLD117NN and H139 stages offer an upgrade pathway in terms of speed and precision, or capacity, respectively.

Part	Description
HLD117NN	Linear motor stage, Nikon Ti
H117P1N4	ProScan inverted stage, part encoded, 1 mm pitch, 400 step, Nikon Ti
H117E1N4	ProScan inverted stage, encoded, 1 mm pitch, 400 step, Nikon Ti
HLD324	Insert adapter assembly, HLD117NN
H473XR	Universal sample holder (slides, Petri dishes, small flasks), extra recessed
H224XRLP	Low profile 3 in x 1 in slide holder, extra recessed
H229XR	Universal Petri dish holder, extra recessed
H234XR	Four 3 in x 1 in slide holder, extra recessed
H23X200	200 ml flask holder (Greiner)
H237XRLP	Low profile 3 in x 2 in slide holder, extra recessed
H229D35XR-6	Holder for 6 x 35 mm Petri dishes
H649	Holder for a single 1 in, 1.25 in and 1.5 in mounted metallurgical specimen
H657	Holder for one mounted metallurgical specimen, 2 in diameter
H658	Holder for six mounted metallurgical specimens, 1.25 in diameter
H659	Holder for one mounted metallurgical specimen, 15 in diameter with 1, 2, 4, or 8 chambers

Large format XY stages and sample holders

Part	Description
H139P1N4	ProScan inverted stage, part encoded, 1 mm pitch (Nikon)
H139E1N5	ProScan inverted stage, encoders, 1 mm pitch ballscrew (Nikon)
H171XR	9 slide holder (H139)
H223XR2	Microtitre insert plate (H139) 2 posn
H473XR3	Universal sample holder x 3 (H139)

Nanopositioning stages and sample holders

Nanopositioning stages require a suitable motorized stage for mounting. They can be directly mounted to the H117P1N4 and H117E1N4. They can be mounted on the HLD117NN via the QGSPADAPT2 adapter. They can be mounted on Nikon motorized stages via the QGSPADAPT1 adapter; please contact Prior to verify your stage model is compatible. Other motorized stage models are not compatible. Note that a sample holder from the nanopositioning stage section is required for use and replaces the sample holder fitted to the motorized stage. Prior nanopositioning stages can be controlled via NIS Elements by serial port connection. Alternative Prior/Queensgate® manufactured nanopositioning stages can also be purchased exclusively from Nikon.

Part	Description
QGSP400-D1	System SP400, 400 µm travel, and NPC-D-6110 controller
QGSP600-D1	System SP600, 600 µm travel, and NPC-D-6110 controller
QGSP800-D1	System SP800, 800 µm travel, and NPC-D-6110 controller
QGSP301XR	SP multiwell holder XR
QGSP302XR	SP universal sample holder XR
QGSP303XR	SP single slide holder suitable for 1 in x3 in and 2 in x3 in slides
QGSPADAPT1	SP400 to Nikon Ti2 motorised stage adapter plate kit
QGSPADAPT2	SP400 to HLD117NN adapter plate kit

Objective positioners and adaptors

When ordering, ensure the correct part number is used to specify inverted calibration. Objective positioners require a threaded adapter to fit the microscope nosepiece and the microscope objective. Nikon microscopes typically use M25 threads; don't hesitate to contact Prior Scientific if the nosepiece uses an alternative thread size. Some Ti nosepieces have a raised lip surrounding the objective positions, which may clash with the objective positioner; a 15 mm spacer can be added to clear the lip. These spacers are also used to ensure any other objectives are parfocal. Please note that the two objective positions adjacent to the objective positioner will not be useable due to space constraints. A high load calibration is available for specialist heavy objectives. Prior objective positioners can be controlled via NIS Elements by serial port connection. Alternative Prior/Queensgate® manufactured objective positioners can also be purchased exclusively from Nikon.

Part	Description
QGOP-400-INV-D1	OP400 objective scanner system incl. NPC-D-6110 controller for inverted microscopes (0 – 500 g load)
QGOP-400-INV-HL-D1	OP400 objective scanner system incl. NPC-D-6110 controller for inverted microscopes (500 – 1000 g load)
QG-OP-MIC-M25	OP microscope adapter M25 x 0.75
QG-OP-OBJ-M25	OP objective adapter M32 x 0.75 to M25 x 0.75
QG-OP-SPACE-M25	M25 x 0.75 static objective spacer to align with OP-400 objective

Motorized focus

The PS3H122R plus H2975 combination is required to drive the fine focus knob of the microscope. The coarse focus will not be motorized. The H122KON direct coupling can be added for more precise motorized control.

Part	Description
PS3H122R	Generic focus drive and adaptor with rotating cable system preventing cable twisting
H2975	Nikon Ti, Ti2 & Ts2R focus sleeve
H122KI2	Direct fine focus coupling kit for Nikon Ti2

Autofocus

The PF850 is standalone hardware autofocus. The PF212 kit is required for mounting on the Ti2-U and Ti2-A. The PF200, PF209 and PF300 are required for setup and maintenance. The PF404 is required for use with piezo nanopositioning systems. The Nikon Perfect Focus System (PFS) is available for the Ti2-E. The Nikon Ti2-LA-SU kit is required to mount the PF850 and can be purchased directly from Nikon.

Part	Description
PF850	PF head, controller with digipot power supply, cables
PF212	Nikon Ti PureFocus kit
PF209	PureFocus setup sample slide
PF201	PureFocus setup camera alignment target type 1, RMS.DIA 0.8 x 36
PF300	PureFocus setup camera jig
PF404	Piezo cable for PF850 15D to BNC

Illumination

The L200NI and L200SNI are recommended for fluorescence microscopy, [see datasheet for details](#). The L200SNI has a built-in shutter mechanism that can be controlled via a ProScan III controller, so a standalone shutter is not required. The LDB103NI requires a ProScan III controller for operation and is recommended if purchasing a V31XYZEF controller. The LDB102NI can be linked to a Nikon controller via the LDBNHUB. 35 mm shutters and filter wheels are recommended for widefield applications.

Part	Description
L200SNI	L200 standard box, lamp, light guide, shutter and Nikon collimator
L200NI	L220 standard box, lamp, light guide and Nikon collimator
L220SNI	L220 standard box, lamp, light guide, shutter and Nikon collimator
L220NI	L220 standard box, lamp, light guide and Nikon collimator
LDB102NI	Brightfield LED, filter slider, standalone, Nikon
LDB103NI	Brightfield LED, filter slider, prior controller, Nikon

Excitation path

Filter wheels are not supplied with filters. Contact Prior Scientific if you wish to purchase a filter wheel stand that can be fixed to an optical table. For systems requiring a shutter and filter wheel, buying one of the combinations listed above is recommended. The HF220 adaptor is required for filter wheels and shutters in the main episcopic illumination pathway.

Part	Description
HF220	Filter wheel adaptor (Nikon)
HF202HT	25 mm high temperature standalone shutter
HF204HT	35 mm high temperature standalone shutter
HF110A	Filter wheel, 10 position, 25 mm diameter filters without stand
HF106A	Filter wheel, 6 position, 25 mm diameter filters without stand
HF108A	Filter wheel, 8 position, 32 mm diameter filters without stand
HF110A + HF200HT	10 position 25 mm diameter filter wheel plus shutter combination
HF108A + HF201HT	8 position 32 mm diameter filter wheel plus shutter combination

Emission path

The HF255 adaptor is required for fitting shutter and filter wheels to the emission port of the microscope. 32 mm shutters and filter wheels are recommended for widefield applications.

Part	Description
HF255	Emission flange set (Nikon Ti)
HF202HT	25mm high temperature standalone shutter
HF204HT	High speed shutter (high temperature), 32 mm aperture, for stand alone use
HF110A	Filter wheel, 10 position, 25 mm diameter filters without stand
HF106A	Filter wheel, 6 position, 25 mm diameter filters without stand
HF108A	Filter wheel, 8 position, 32 mm diameter filters without stand
HF110A + HF200HT	10 position 25 mm diameter filter wheel plus shutter combination
HF108A + HF201HT	8 position 32 mm diameter filter wheel plus shutter combination

Deck inserts

The HF6NTK motorized filter turret has 6 positions and can be controlled by any Prior controller that can control filter wheels and shutters.

Part	Description
HF6NTK	Nikon filter turret upgrade Ti2 (MOTFILTTi2A)

Well plate loader

The PLW20N can be controlled by NIS elements combined with the HLD117NN stage. No other stages are compatible. The HLW223XR is required and fits directly into the HLD117NN without an adapter. The PLW106 barcode reader is an optional extra but must be specified at the point of purchase for calibration.

Part	Description
PLW20N	Well plate loader, Nikon
HLD117NN	Linear motor stage, Nikon Ti
HLW223XR	High speed shutter (high temperature), 32 mm aperture, for stand alone use
PLW106	Barcode reader wellplate loader

Nikon Ti configuration chart

See the following pages for more product information.

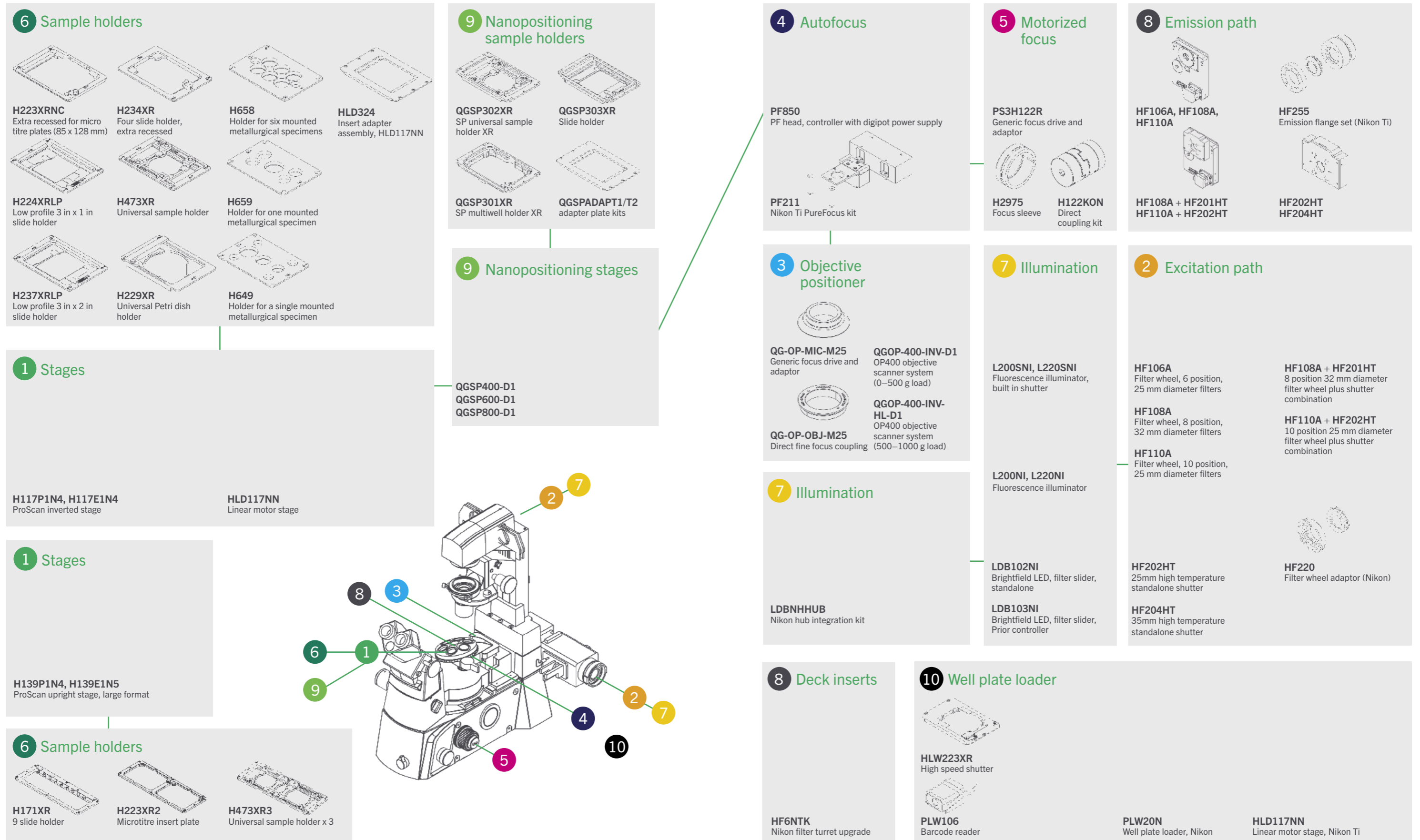

Nikon Ti configuration guide

The Nikon Ti has three variants; Ti-U (non-motorized), Ti-S (non-motorized, second imaging port), and Ti-E (fully motorized). Prior Scientific can supply motorized upgrades for all product types to the Ti-U and Ti-S. The Ti-E can be upgraded with Prior Scientific stages, nanopositioning stages, objective positioners, and autofocus, which enhance the capabilities of this fully motorized system.

Motorized XY stages and sample holders

All the sample holders listed are compatible with the H117P1N4, H117E1N4, and HLD117NN. The HLD324 is required for Prior sample holders when using the HLD117NN. Nikon sample holders can be fitted to the HLD117NN only. At least one sample holder is required. The H139P1N4 and H139E1N5 are available for customers wanted to expand their analysis to a pair of well plates or Petri dishes or up to nine slides. Sample holders associated with the H139 stage range must be used. The H139E1N5 is fitted with 50 nm encoders. The Ti-E features a motorized stage but the HLD117NN and H139 stages offer an upgrade pathway in terms of speed and precision, or capacity, respectively.

Part	Description
HLD117NN	Linear motor stage, Nikon Ti
H117P1N4	ProScan inverted stage, part encoded, 1 mm pitch, 400 step, Nikon Ti
H117E1N4	ProScan inverted stage, encoded, 1 mm pitch, 400 step, Nikon Ti
HLD324	Insert adapter assembly, HLD117NN
H473XR	Universal sample holder (slides, Petri dishes, small flasks), extra recessed
H224XRLP	Low profile 3 in x 1 in slide holder, extra recessed
H229XR	Universal Petri dish holder, extra recessed
H234XR	Four 3 in x 1 in slide holder, extra recessed
H23X200	200 ml flask holder (Greiner)
H237XRLP	Low profile 3 in x 2 in slide holder, extra recessed
H229D35XR-6	Holder for 6 x 35 mm Petri dishes
H649	Holder for a single 1 in, 1.25 in and 1.5 in mounted metallurgical specimen
H657	Holder for one mounted metallurgical specimen, 2 in diameter
H658	Holder for six mounted metallurgical specimens, 1.25 in diameter
H659	Holder for one mounted metallurgical specimen, 15 in diameter with 1, 2, 4, or 8 chambers

Large format XY stages and sample holders

Part	Description
H139P1N4	ProScan inverted stage, part encoded, 1 mm pitch (Nikon)
H139E1N5	ProScan inverted stage, encoders, 1 mm pitch ballscrew (Nikon)
H171XR	9 slide holder (H139)
H223XR2	Microtitre insert plate (H139) 2 posn
H473XR3	Universal sample holder x 3 (H139)

Nanopositioning stages and sample holders

Nanopositioning stages require a suitable motorized stage for mounting. They can be directly mounted to the H117P1N4 and H117E1N4. They can be mounted on the HLD117NN via the QGSPADAPT2 adapter. They can be mounted on Nikon motorized stages via the QGSPADAPT1 adapter; please contact Prior to verify your stage model is compatible. Other motorized stage models are not compatible. Note that a sample holder from the nanopositioning stage section is required for use and replaces the sample holder fitted to the motorized stage. Prior nanopositioning stages can be controlled via NIS Elements by serial port connection. Alternative Prior/Queensgate® manufactured nanopositioning stages can also be purchased exclusively from Nikon.

Part	Description
QGSP400-D1	System SP400, 400 µm travel, and NPC-D-6110 controller
QGSP600-D1	System SP600, 600 µm travel, and NPC-D-6110 controller
QGSP800-D1	System SP800, 800 µm travel, and NPC-D-6110 controller
QGSP301XR	SP multiwell holder XR
QGSP302XR	SP universal sample holder XR
QGSP303XR	SP single slide holder suitable for 1 in x3 in and 2 in x3 in slides
QGSPADAPT1	SP400 to Nikon Ti2 motorised stage adapter plate kit
QGSPADAPT2	SP400 to HLD117NN adapter plate kit

Objective positioners and adaptors

When ordering, ensure the correct part number is used to specify inverted calibration. Objective positioners require a threaded adapter to fit the microscope nosepiece and the microscope objective. Nikon microscopes typically use M25 threads; don't hesitate to contact Prior Scientific if the nosepiece uses an alternative thread size. Some Ti nosepieces have a raised lip surrounding the objective positions, which may clash with the objective positioner; a 15 mm spacer can be added to clear the lip. These spacers are also used to ensure any other objectives are parfocal. Please note that the two objective positions adjacent to the objective positioner will not be useable due to space constraints. A high load calibration is available for specialist heavy objectives. Prior objective positioners can be controlled via NIS Elements by serial port connection. Alternative Prior/Queensgate® manufactured objective positioners can also be purchased exclusively from Nikon.

Part	Description
QGOP-400-INV-D1	OP400 objective scanner system incl. NPC-D-6110 controller for inverted microscopes (0 – 500 g load)
QGOP-400-INV-HL-D1	OP400 objective scanner system incl. NPC-D-6110 controller for inverted microscopes (500 – 1000 g load)
QG-OP-MIC-M25	OP microscope adapter M25 x 0.75
QG-OP-OBJ-M25	OP objective adapter M32 x 0.75 to M25 x 0.75
QG-OP-SPACE-M25	M25 x 0.75 static objective spacer to align with OP-400 objective

Motorized focus

The PS3H122R plus H2975 combination is required to drive the fine focus knob of the microscope. The coarse focus will not be motorized. The H122KON direct coupling can be added for more precise motorized control.

Part	Description
PS3H122R	Generic focus drive and adaptor with rotating cable system preventing cable twisting
H2975	Nikon Ti, Ti2 & Ts2R focus sleeve
H122KON	Direct coupling kit, focus drive assembly

Autofocus

The PF850 is standalone hardware autofocus. The PF211 kit is required for mounting. The PF200, PF209 and PF300 are required for setup and maintenance. The PF404 is required for use with piezo nanopositioning systems.

Part	Description
PF850	PF head, controller with digipot power supply, cables
PF211	Nikon Ti PureFocus kit
PF209	PureFocus setup sample slide
PF201	PureFocus setup camera alignment target type 1, RMS.DIA 0.8 x 36
PF300	PureFocus setup camera jig
PF404	Piezo cable for PF850 15D to BNC

Illumination

The L200NI and L200SNI are recommended for fluorescence microscopy, [see datasheet for details](#). The L200SNI has a built-in shutter mechanism that can be controlled via a ProScan III controller, so a standalone shutter is not required. The LDB103NI requires a ProScan III controller for operation and is recommended if purchasing a V31XYZEF controller. The LDB102NI can be linked to a Nikon controller via the LDBNHUB. 35 mm shutters and filter wheels are recommended for widefield applications.

Part	Description
L200SNI	L200 standard box, lamp, light guide, shutter and Nikon collimator
L200NI	L220 standard box, lamp, light guide and Nikon collimator
L220SNI	L220 standard box, lamp, light guide, shutter and Nikon collimator
L220NI	L220 standard box, lamp, light guide and Nikon collimator
LDB102NI	Brightfield LED, filter slider, standalone, Nikon
LDB103NI	Brightfield LED, filter slider, prior controller, Nikon
LDBNHUB	Hub for Nikon Ti Microscope to allow control of Brightfield LED via the microscope illumination control and NIS Elements.

Excitation path

Filter wheels are not supplied with filters. Contact Prior Scientific if you wish to purchase a filter wheel stand that can be fixed to an optical table. For systems requiring a shutter and filter wheel, buying one of the combinations listed above is recommended. The HF220 adaptor is required for filter wheels and shutters in the main episcopic illumination pathway.

Part	Description
HF220	Filter wheel adaptor (Nikon)
HF202HT	25 mm high temperature standalone shutter
HF204HT	35 mm high temperature standalone shutter
HF110A	Filter wheel, 10 position, 25 mm diameter filters without stand
HF106A	Filter wheel, 6 position, 25 mm diameter filters without stand
HF108A	Filter wheel, 8 position, 32 mm diameter filters without stand
HF110A + HF200HT	10 position 25 mm diameter filter wheel plus shutter combination
HF108A + HF201HT	8 position 32 mm diameter filter wheel plus shutter combination

Emission path

The HF255 adaptor is required for fitting shutter and filter wheels to the emission port of the microscope. 32 mm shutters and filter wheels are recommended for widefield applications.

Part	Description
HF255	Emission flange set (Nikon Ti)
HF202HT	25mm high temperature standalone shutter
HF204HT	High speed shutter (high temperature), 32 mm aperture, for stand alone use
HF110A	Filter wheel, 10 position, 25 mm diameter filters without stand
HF106A	Filter wheel, 6 position, 25 mm diameter filters without stand
HF108A	Filter wheel, 8 position, 32 mm diameter filters without stand
HF110A + HF200HT	10 position 25 mm diameter filter wheel plus shutter combination
HF108A + HF201HT	8 position 32 mm diameter filter wheel plus shutter combination

Deck inserts

The HF6NTK motorized filter turret has 6 positions and can be controlled by any Prior controller that can control filter wheels and shutters.

Part	Description
HF6NTK	Nikon filter turret upgrade Ti

Well plate loader

The PLW20N can be controlled by NIS elements combined with the HLD117NN stage. No other stages are compatible. The HLW223XR is required and fits directly into the HLD117NN without an adapter. The PLW106 barcode reader is an optional extra but must be specified at the point of purchase for calibration.

Part	Description
PLW20N	Well plate loader, Nikon
HLD117NN	Linear motor stage, Nikon Ti
HLW223XR	High speed shutter (high temperature), 32 mm aperture, for stand alone use
PLW106	Barcode reader wellplate loader

Nikon Ts2R configuration chart

See the following pages for more product information.

6 Sample holders

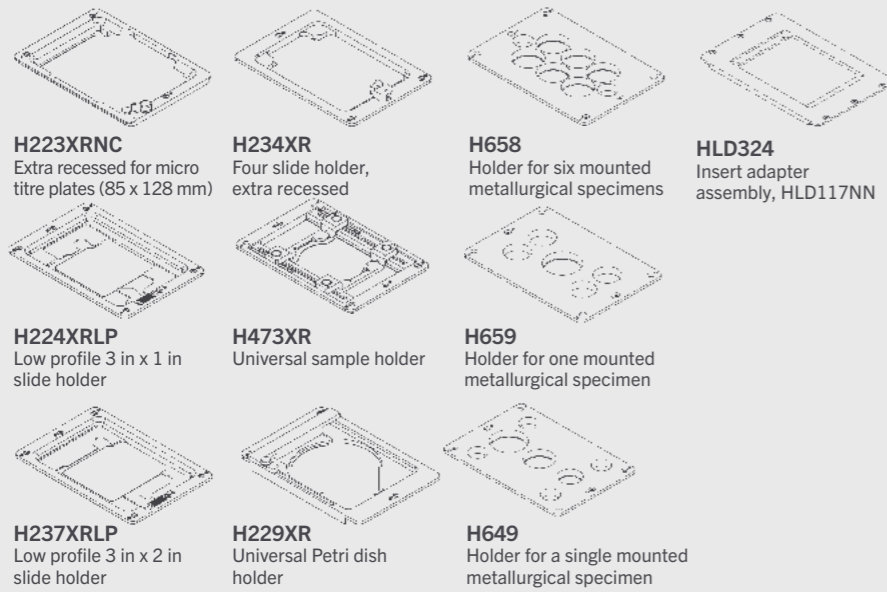

9 Nanopositioning sample holders

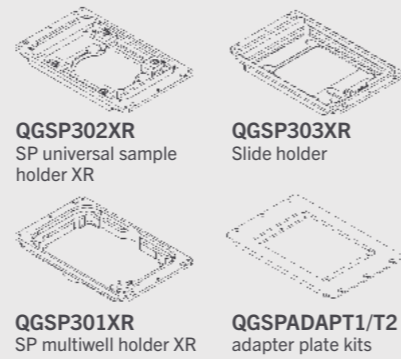

9 Nanopositioning stages

QGSP400-D1
QGSP600-D1
QGSP800-D1

1 Stages

H117P1N4, H117E1N4
ProScan inverted stage

HLD117NN
Linear motor stage

1 Stages

H139P1N4, H139E1N5
ProScan upright stage, large format

6 Sample holders



3 Objective positioner

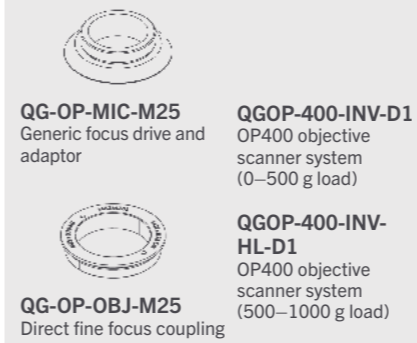

5 Motorized focus



8 Emission path

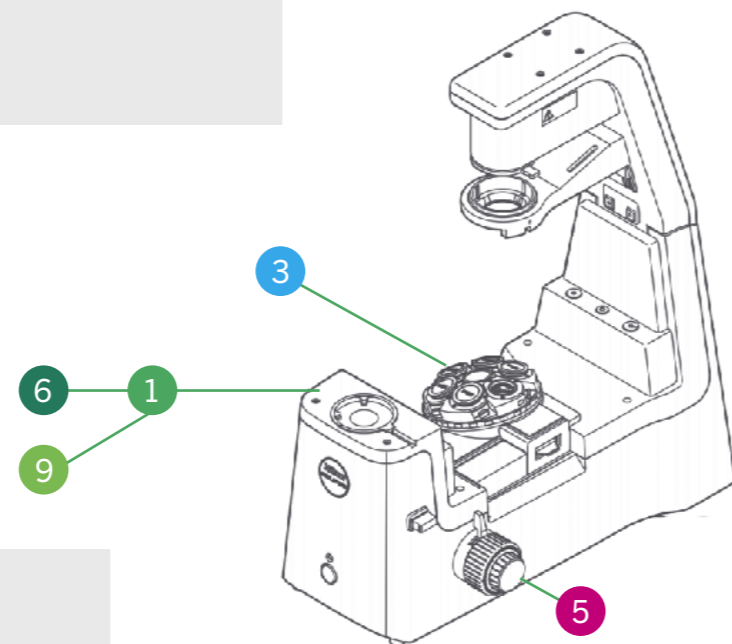
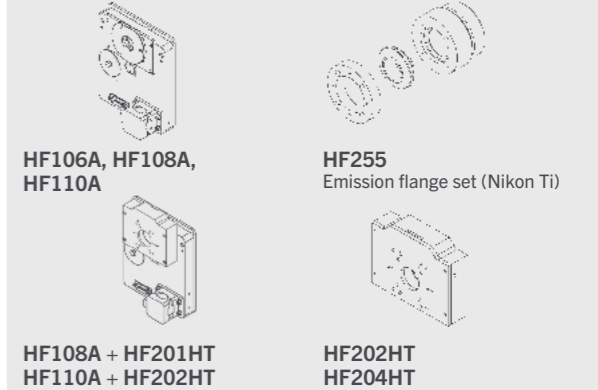

Nikon Ts2R configuration guide

The Nikon Ts2R is a manual laboratory microscope. Prior Scientific's upgrades for this microscope focus on XYZ motorization and nan positioning solutions.

Motorized XY stages and sample holders

All the sample holders listed are compatible with the H117P1N4, H117E1N4, and HLD117NN. The HLD324 is required for Prior sample holders when using the HLD117NN. Nikon sample holders can be fitted to the HLD117NN only. At least one sample holder is required. The H139P1N4 and H139E1N5 are available for customers wanted to expand their analysis to a pair of well plates or Petri dishes or up to nine slides. Sample holders associated with the H139 stage range must be used. The H139E1N5 is fitted with 50 nm encoders.

Part	Description
HLD117NN	Linear motor stage, Nikon Ti
H117P1N4	ProScan inverted stage, part encoded, 1 mm pitch, 400 step, Nikon Ti
H117E1N4	ProScan inverted stage, encoded, 1 mm pitch, 400 step, Nikon Ti
HLD324	Insert adapter assembly, HLD117NN
H473XR	Universal sample holder (slides, Petri dishes, small flasks), extra recessed
H224XRLP	Low profile 3 in x 1 in slide holder, extra recessed
H229XR	Universal Petri dish holder, extra recessed
H234XR	Four 3 in x 1 in slide holder, extra recessed
H23X200	200 ml flask holder (Greiner)
H237XRLP	Low profile 3 in x 2 in slide holder, extra recessed
H229D35XR-6	Holder for 6 x 35 mm Petri dishes
H649	Holder for a single 1 in, 1.25 in and 1.5 in mounted metallurgical specimen
H657	Holder for one mounted metallurgical specimen, 2 in diameter
H658	Holder for six mounted metallurgical specimens, 1.25 in diameter
H659	Holder for one mounted metallurgical specimen, 15 in diameter with 1, 2, 4, or 8 chambers

Large format XY stages and sample holders

Part	Description
H139P1N4	ProScan inverted stage, part encoded, 1 mm pitch (Nikon)
H139E1N5	ProScan inverted stage, encoders, 1 mm pitch ballscrew (Nikon)
H171XR	9 slide holder (H139)
H223XR2	Microtitre insert plate (H139) 2 posn
H473XR3	Universal sample holder x 3 (H139)

Nan positioning stages and sample holders

Nan positioning stages require a suitable motorized stage for mounting. They can be directly mounted to the H117P1N4 and H117E1N4. They can be mounted on the HLD117NN via the QGSPADAPT2 adapter. They can be mounted on Nikon motorized stages via the QGSPADAPT1 adapter; please contact Prior Scientific to verify your stage model is compatible. Other motorized stage models are not compatible. Note that a sample holder from the nan positioning stage section is required for use and replaces the sample holder fitted to the motorized stage. Prior nan positioning stages can be controlled via NIS Elements by serial port connection. Alternative Prior/Queensgate® manufactured nan positioning stages can also be purchased exclusively from Nikon.

Part	Description
QGSP400-D1	System SP400, 400 µm travel, and NPC-D-6110 controller
QGSP600-D1	System SP600, 600 µm travel, and NPC-D-6110 controller
QGSP800-D1	System SP800, 800 µm travel, and NPC-D-6110 controller
QGSP301XR	SP multiwell holder XR
QGSP302XR	SP universal sample holder XR
QGSP303XR	SP single slide holder suitable for 1 in x3 in and 2 in x3 in slides
QGSPADAPT1	SP400 to Nikon Ti2 motorised stage adapter plate kit
QGSPADAPT2	SP400 to HLD117NN adapter plate kit

Objective positioners and adaptors

When ordering, ensure the correct part number is used to specify inverted calibration. Objective positioners require a threaded adapter to fit the microscope nosepiece and the microscope objective. Nikon microscopes typically use M25 threads; don't hesitate to contact Prior Scientific if the nosepiece uses an alternative thread size. Some Ti nosepieces have a raised lip surrounding the objective positions, which may clash with the objective positioner; a 15 mm spacer can be added to clear the lip. These spacers are also used to ensure any other objectives are parfocal. Please note that the two objective positions adjacent to the objective positioner will not be useable due to space constraints. A high load calibration is available for specialist heavy objectives. Prior objective positioners can be controlled via NIS Elements by serial port connection. Alternative Prior/Queensgate® manufactured objective positioners can also be purchased exclusively from Nikon.

Part	Description
QGOP-400-INV-D1	OP400 objective scanner system incl. NPC-D-6110 controller for inverted microscopes (0 – 500 g load)
QGOP-400-INV-HL-D1	OP400 objective scanner system incl. NPC-D-6110 controller for inverted microscopes (500 – 1000 g load)
QG-OP-MIC-M25	OP microscope adapter M25 x 0.75
QG-OP-OBJ-M25	OP objective adapter M32 x 0.75 to M25 x 0.75
QG-OP-SPACE-M25	M25 x 0.75 static objective spacer to align with OP-400 objective

Motorized focus

The PS3H122R plus H2975 combination is required to drive the fine focus knob of the microscope. The coarse focus will not be motorized. The H122KON direct coupling can be added for more precise motorized control.

Part	Description
PS3H122R	Generic focus drive and adaptor with rotating cable system preventing cable twisting
H2975	Nikon Ti, Ti2 & Ts2R focus sleeve
H122KON	Direct coupling kit, focus drive assembly

Nikon TE2000 configuration chart

See the following pages for more product information.

6 Sample holders

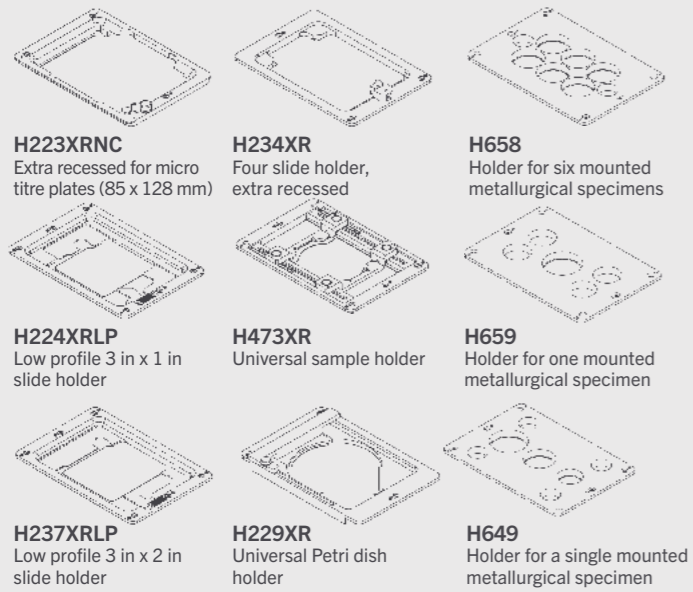

9 Nanopositioning sample holders

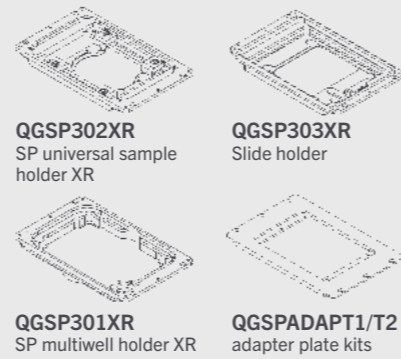

9 Nanopositioning stages

QGSP400-D1
QGSP600-D1
QGSP800-D1

1 Stages

H117P1N4, H117E1N4
ProScan inverted stage

H117P1T4, H117E1T4

3 Objective positioner

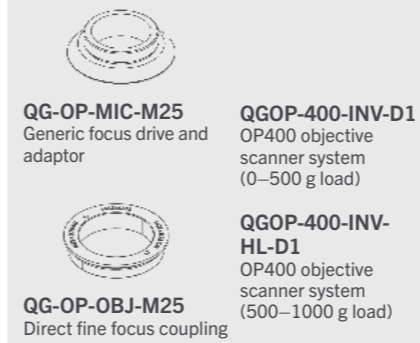

5 Motorized focus



8 Emission path

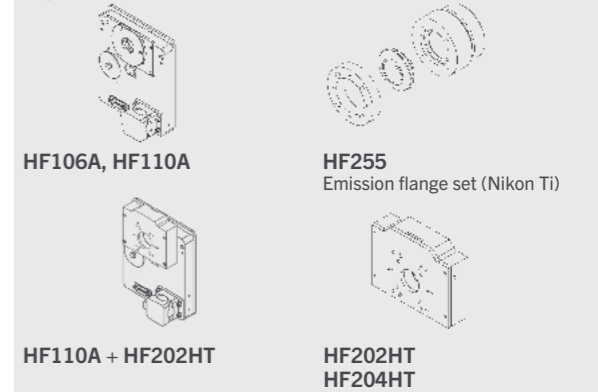

7 Illumination

L200SIX, L220SNI
Fluorescence illuminator, built in shutter

L200IX, L220NI
Fluorescence illuminator

LDB102NI
Brightfield LED, filter slider, standalone

LDB103NI
Brightfield LED, filter slider, Prior controller

2 Excitation path

HF106A
Filter wheel, 6 position, 25 mm diameter filters

HF108A
Filter wheel, 8 position, 32 mm diameter filters

HF110A
Filter wheel, 10 position, 25 mm diameter filters

HF220
Filter wheel adaptor (Nikon)

HF108A + HF201HT
8 position 32 mm diameter filter wheel plus shutter combination

HF110A + HF202HT
10 position 25 mm diameter filter wheel plus shutter combination

HF200
Shutter adaptor (Nikon)

HF202HT
25mm high temperature standalone shutter

HF204HT
35mm high temperature standalone shutter

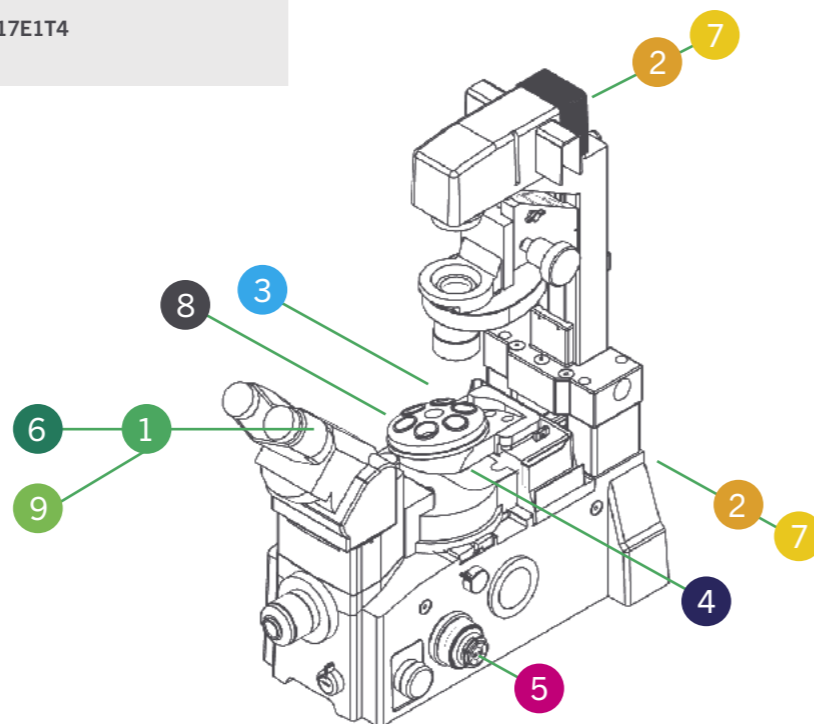

Nikon TE2000 configuration guide

The Nikon TE2000 is an older generation inverted microscope. Prior Scientific can provide multiple upgrades for this microscope.

Motorized XY stages and sample holders

All the sample holders listed are compatible with the H117P1N4, H117E1N4, H117P1T4, and H117E1T4. At least one sample holder is required. Nikon TE2000s with a non-motorized filter turret can be fitted with the H117P1N4 and H117E1N4. Nikon TE2000s with a motorized filter turret can only be fitted with the H117P1T4 and H117E1T4. Please contact Prior before quoting or ordering an H117P1T4 or H117E1T4 to confirm availability and discuss your requirements. An OptiScan alternative (ES107NTE) to the H117P1T4/H117E1T4 is available.

Part	Description
H117P1N4	ProScan inverted stage, part encoded, 1 mm pitch, 400 step, Nikon Ti
H117E1N4	ProScan inverted stage, encoded, 1 mm pitch, 400 step, Nikon Ti
H117P1T4	
H117E1T4	
H473XR	Universal sample holder (slides, Petri dishes, small flasks), extra recessed
H224XRLP	Low profile 3 in x 1 in slide holder, extra recessed
H229XR	Universal Petri dish holder, extra recessed
H234XR	Four 3 in x 1 in slide holder, extra recessed
H23X200	200 ml flask holder (Greiner)
H237XRLP	Low profile 3 in x 2 in slide holder, extra recessed
H229D35XR-6	Holder for 6 x 35 mm Petri dishes
H649	Holder for a single 1 in, 1.25 in and 1.5 in mounted metallurgical specimen
H657	Holder for one mounted metallurgical specimen, 2 in diameter
H658	Holder for six mounted metallurgical specimens, 1.25 in diameter
H659	Holder for one mounted metallurgical specimen, 15 in diameter with 1, 2, 4, or 8 chambers

Nanopositioning stages and sample holders

Nanopositioning stages require a suitable motorized stage for mounting. They can be directly mounted to the H117P1N4 and H117E1N4. They can be mounted on some Nikon stages via the QGSPADAPT1 adapter; please contact Prior Scientific to verify your stage model is compatible. Other motorized stage models are not compatible. Note that a sample holder from the nanopositioning stage section is required for use and replaces the sample holder fitted to the motorized stage. Prior Scientific nanopositioning stages can be controlled via NIS Elements by serial port connection. Alternative Prior Scientific/Queensgate[®] manufactured nanopositioning stages can also be purchased exclusively from Nikon.

Part	Description
QGSP400-D1	System SP400, 400 µm travel, and NPC-D-6110 controller
QGSP600-D1	System SP600, 600 µm travel, and NPC-D-6110 controller
QGSP800-D1	System SP800, 800 µm travel, and NPC-D-6110 controller
QGSP301XR	SP multiwell holder XR
QGSP302XR	SP universal sample holder XR
QGSP303XR	SP single slide holder suitable for 1 in x3 in and 2 in x3 in slides
QGSPADAPT1	SP400 to Nikon Ti2 motorised stage adapter plate kit
QGSPADAPT2	SP400 to HLD117NN adapter plate kit

Objective positioners and adaptors

When ordering, ensure the correct part number is used to specify inverted calibration. Objective positioners require a threaded adapter to fit the microscope nosepiece and the microscope objective. Nikon microscopes typically use M25 threads; please contact Prior Scientific if the nosepiece uses an alternative thread size. Some TE2000 nosepieces have a raised lip surrounding the objective positions, which may clash with the objective positioner; a 15 mm spacer can be added to clear the lip. These spacers are also used to ensure any other objectives are parfocal. Please note that the two objective positions adjacent to the objective positioner will not be useable due to space constraints. A high load calibration is available for specialist heavy objectives. Prior objective positioners can be controlled via NIS Elements by serial port connection. Alternative Prior Scientific/Queensgate[®] manufactured objective positioners can also be purchased exclusively from Nikon.

Part	Description
QGOP-400-INV-D1	OP400 objective scanner system incl. NPC-D-6110 controller for inverted microscopes (0 – 500 g load)
QGOP-400-INV-HL-D1	OP400 objective scanner system incl. NPC-D-6110 controller for inverted microscopes (500 – 1000 g load)
QG-OP-MIC-M25	OP microscope adapter M25 x 0.75
QG-OP-OBJ-M25	OP objective adapter M32 x 0.75 to M25 x 0.75
QG-OP-SPACE-M25	M25 x 0.75 static objective spacer to align with OP-400 objective

Motorized focus

The PS3H122R plus H2975 combination is required to drive the fine focus knob of the microscope. The coarse focus will not be motorized. The H122KON direct coupling can be added for more precise motorized control.

Part	Description
PS3H122R	Generic focus drive and adaptor with rotating cable system preventing cable twisting
H2193	Nikon TE2000 focus sleeve
H122KON	Direct coupling kit, focus drive assembly

Illumination

The L200NI and L200SNI are recommended for fluorescence microscopy, [see datasheet for details](#). The L200SNI has a built-in shutter mechanism that can be controlled via a ProScan III controller, so a standalone shutter is not required. The LDB103NI requires a ProScan III controller for operation and is recommended if purchasing a V31XYZEF controller. The LDB102NI can be linked to a Nikon controller via the LDBNHUB. 35 mm shutters and filter wheels are recommended for widefield applications.

Part	Description
L200SNI	L200 standard box, lamp, light guide, shutter and Nikon collimator
L200NI	L220 standard box, lamp, light guide and Nikon collimator
L220SNI	L220 standard box, lamp, light guide, shutter and Nikon collimator
L220NI	L220 standard box, lamp, light guide and Nikon collimator
LDB102NI	Brightfield LED, filter slider, standalone, Nikon
LDB103NI	Brightfield LED, filter slider, prior controller, Nikon

Excitation path

Filter wheels are not supplied with filters. Contact Prior Scientific if you wish to purchase a filter wheel stand that can be fixed to an optical table. For systems requiring a shutter and filter wheel, buying one of the combinations listed above is recommended. The HF220 adaptor is required for filter wheels and shutters in the main episcopic illumination pathway.

Part	Description
HF220	Filter wheel adaptor (Nikon)
HF200	Filter wheel adapter for Nikon Eclipse TE2000 series microscopes.
HF202HT	25 mm high temperature standalone shutter
HF204HT	35 mm high temperature standalone shutter
HF110A	Filter wheel, 10 position, 25 mm diameter filters without stand
HF106A	Filter wheel, 6 position, 25 mm diameter filters without stand
HF108A	Filter wheel, 8 position, 32 mm diameter filters without stand
HF110A + HF200HT	10 position 25 mm diameter filter wheel plus shutter combination
HF108A + HF201HT	8 position 32 mm diameter filter wheel plus shutter combination

Emission path

The HF255 adaptor is required for fitting shutter and filter wheels to the emission port of the microscope. 32 mm shutters and filter wheels are recommended for widefield applications.

Part	Description
HF227	Filter wheel adapter for Nikon Eclipse TE2000 series microscopes.
HF202HT	25mm high temperature standalone shutter
HF204HT	High speed shutter (high temperature), 32 mm aperture, for stand alone use
HF110A	Filter wheel, 10 position, 25 mm diameter filters without stand
HF106A	Filter wheel, 6 position, 25 mm diameter filters without stand
HF110A + HF200HT	10 position 25 mm diameter filter wheel plus shutter combination

Nikon Ni configuration chart

See the following pages for more product information.

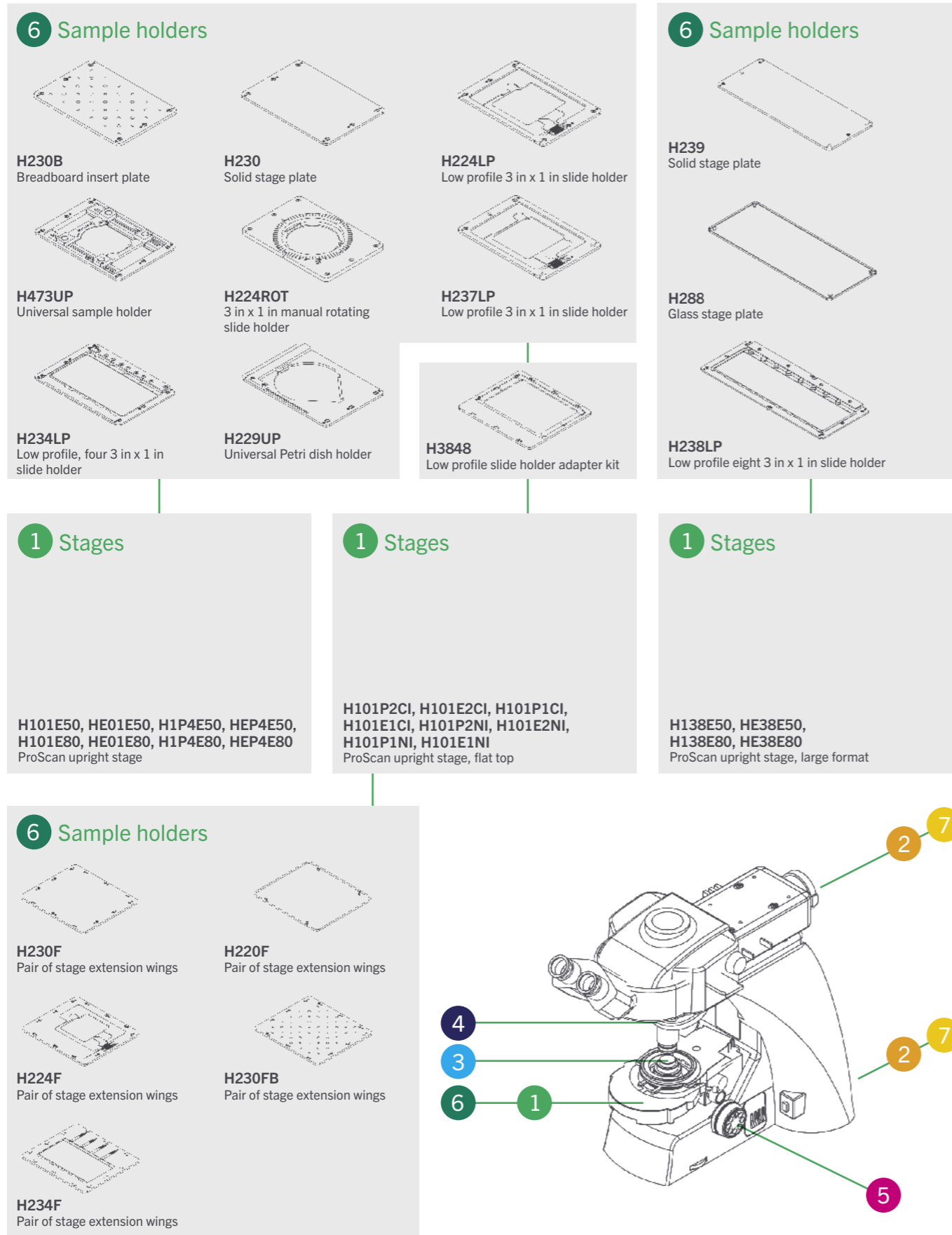

Contact Prior Scientific about robotic slide loading solutions.

Nikon Ni configuration guide

The Nikon Ni is an upright microscope with three variants; Ni-E (focusing stage type), Ni-E (focusing nosepiece type), and Ni-U. The below information refers only to the Ni-E (focusing stage type) and Ni-U. Please refer to the following section for the Ni-E (focusing nosepiece type). Prior Scientific offers an extensive range of upgrades for this microscope.

Motorized XY stages and sample holders

Many stages are compatible with the Ni-E (focusing stage type) and Ni-U. Stages with the suffix –E80 and –NI are compatible with the Ni-E (focusing stage type) and with the Ni-U when fitted with a Nikon SSR substage. Stages with the suffix –E50 and –CI are compatible with the Ni-U when fitted with a Nikon SS substage only. All the sample holders listed in the first section of the above table are compatible with the H101E50, HE01E50, H1P4E50, HEP4E50, H101E80, HE01E80, H1P4E80, and HEP4E80. All the sample holders listed in the second section are compatible with the flat top H101P2CI, H101E2CI, H101P1CI, H101E1CI, H101P2NI, H101E2NI, H101P1NI, and H101E1NI. In addition, sample holders from the first section are compatible with the flat top stage range when combined with the H3848. The large-format H138E50, HE38BE50, H138E80, and HE38E80 can support up to 8 slides.

Part	Description
H101E50	ProScan upright stage, part encoded, 2 mm pitch, 200 step, Nikon SS substage
HE01E50	ProScan upright stage, encoded, 2 mm pitch, 200 step, Nikon SS substage
H1P4E50	ProScan upright stage, part encoded, 1 mm pitch, 400 step, Nikon SS substage
HEP4E50	ProScan upright stage, encoded, 1 mm pitch, 400 step, Nikon SS substage
H101E80	ProScan upright stage, part encoded, 2 mm pitch, 200 step, Nikon SSR substage
HE01E80	ProScan upright stage, encoded, 2 mm pitch, 200 step, Nikon SSR substage
H1P4E80	ProScan upright stage, part encoded, 1 mm pitch, 400 step, Nikon SSR substage
HEP4E80	ProScan upright stage, encoded, 1 mm pitch, 400 step, Nikon SSR substage
H473UP	Universal sample holder (slides, Petri dishes, small flasks), upright
H224LP	Low profile 3 in x 1 in slide holder
H234LP	Low profile, four 3 in x 1 in slide holder
H237LP	Low profile 3 in x 2 in slide holder
H229UP	Universal Petri dish holder, upright stages, up to 90 mm diameter
H230	Solid stage plate, H101A stages
H224ROT	3 in x 1 in manual rotating slide holder
H230B	Breadboard insert plate M4 & M6 (H101)
H220	H101 glass stage plate assy

Large Format XY motorized stages and sample holders

Part	Description
H138E50	ProScan upright stage, part encoded, 2 mm pitch, 200 step, for up to 8 slides, Nikon SS substage
HE38E50	ProScan upright stage, encoded, 2 mm pitch, 200 step, for up to 8 slides, Nikon SS substage
H138E80	ProScan upright stage, part encoded, 2 mm pitch, 200 step, for up to 8 slides, Nikon SSR substage
HE38E80	ProScan upright stage, encoded, 2 mm pitch, 200 step, for up to 8 slides, Nikon SSR substage
H238LP	Low profile eight 3 in x 1 in slide holder
H238PLP	Low profile eight 3 in x 1 in slide holder, part recessed
H239	Solid stage plate, H138 stages
H288	Glass stage plate, H138 stages

Flat top XY motorized stages and sample holders

Part	Description
H101P2CI	Proscan upright stage, flat top, 2 mm pitch, 200 step, Nikon SS substage
H101E2CI	Proscan upright stage, flat top, encoded, 2 mm pitch, 200 step, Nikon SS substage
H101P1CI	Proscan upright stage, flat top, 1 mm pitch, 200 step, Nikon SS substage
H101E1CI	Proscan upright stage, flat top, encoded, 1 mm pitch, 200 step, Nikon SS substage
H101P2NI	Proscan upright stage, flat top, 2 mm pitch, 200 step, Nikon SSR substage
H101E2NI	Proscan upright stage, flat top, encoded, 2 mm pitch, 200 step, Nikon SSR substage
H101P1NI	Proscan upright stage, flat top, 1 mm pitch, 200 step, Nikon SSR substage
H101E1NI	Proscan upright stage, flat top, encoded, 1 mm pitch, 200 step, Nikon SSR substage
H3848	Low profile slide holder adapter kit for H101F
H230F	Solid stage plate, H101F stages
H224F	Low profile 3 in x 1 in slide holder, extended, H101F stages
H234F	Four 3 in x 1 in slide holder, H101F stages
H220F	Glass stage plate, H101F stages
H230FB	Breadboard stage insert assembly (H101F)

Objective positioners and adaptors

When ordering, ensure the correct part number is used to specify inverted calibration. Objective positioners require a threaded adapter to fit the microscope nosepiece and the microscope objective. Nikon microscopes typically use RMS threads; please contact Prior Scientific if the nosepiece uses an alternative thread size. Some Ni nosepieces have a raised lip surrounding the objective positions, which may clash with the objective positioner; a 15 mm spacer can be added to clear the lip. Please note that the two objective positions adjacent to the objective positioner will not be useable due to space constraints; additional positions may be unusable on smaller nosepieces. A high load calibration is available for specialist heavy objectives. Prior objective positioners can be controlled via NIS Elements by serial port connection. Alternative Prior/Queensgate® manufactured objective positioners can also be purchased exclusively from Nikon.

Part	Description
QGOP-400-UP-D1	OP400 objective scanner system incl. NPC-D-6110 controller for inverted microscopes (0 – 500 g load)
QGOP-400-UP-HL-D1	OP400 objective scanner system incl. NPC-D-6110 controller for inverted microscopes (500 – 1000 g load)
QG-OP-MIC-M25	OP microscope adapter M25 x 0.75
QG-OP-OBJ-M25	OP objective adapter M32 x 0.75 to M25 x 0.75
QG-OP-SPACE-M25	M25 x 0.75 static objective spacer to align with OP-400 objective

Motorized focus

The PS3H122R plus H3940 combination is required to drive the fine focus knob of the Ni-U microscope. The coarse focus will not be motorized. The H122KNI direct coupling can be added for more precise motorized control. The Ni-E (focusing stage type) contains an inherent motorized focus, so no Prior Scientific focus motor is required unless using the PF850 autofocus.

Part	Description
PS3H122R	Generic focus drive and adaptor with rotating cable system preventing cable twisting
H3940	Nikon Ni-U/Ni-C focus sleeve.
H122KNI	Direct fine focus coupling kit for Nikon 50i / 80i / 90i.

Autofocus

The PF850 is standalone hardware autofocus. The PF850 should be mounted between the objective and filter turret for fluorescence imaging. The PF200, PF209, and PF300 are required for setup and maintenance. The PF404 is required for use with piezo nanopositioning systems. Please note that the Ni-E inherent motorized focus cannot be used with the PF850. Additionally, the Ni-E motorized focus may cause some focus knob oscillation on the microscope when used with the PS2H122R, but this has not been shown to translate to problems when capturing images.

Part	Description
PF850	PF head, controller with digipot power supply, cables
LF320	PF850 flange set (Nikon)
PF209	PureFocus setup sample slide
PF201	PureFocus setup camera alignment target type 2, DIA 25 x 0.75
PF300	PureFocus setup camera jig
PF404	Piezo cable for PF850 15D to BNC

Illumination

The L200NI and L200SNI are recommended for fluorescence microscopy, [see datasheet for details](#). Note that the L200SNI has a built-in shutter mechanism that can be controlled via a ProScan III controller, so a standalone shutter is not required. The L220NI and L220SNI are available for customers doing fluorescence imaging in the far-red. The L200 and L220 systems can be fitted to the NI-FLEI episcopic attachment or other attachments that take 9 mm diameter liquid light guides. The LDB103NI requires a ProScan III controller for operation and is recommended if purchasing a V31XYZEF controller. 35 mm shutters and 32 mm filter wheels are recommended for widefield applications.

Part	Description
L200SNI	L200 standard box, lamp, light guide, shutter and Nikon collimator
L200NI	L220 standard box, lamp, light guide and Nikon collimator
L220SNI	L220 standard box, lamp, light guide, shutter and Nikon collimator
L220NI	L220 standard box, lamp, light guide and Nikon collimator
LDB102NI	Brightfield LED, filter slider, standalone, Nikon
LDB103NI	Brightfield LED, filter slider, prior controller, Nikon

Excitation path

Filter wheels are not supplied with filters. Contact Prior Scientific if you wish to purchase a filter wheel stand that can be fixed to an optical table. For systems requiring a shutter and filter wheel, it is recommended to buy one of the combinations listed above. The HF220 adaptor is needed for filter wheels and shutters in the episcopic (via the NI-FLEI episcopic attachment).

Part	Description
HF220	Filter wheel adaptor (Nikon)
HF202HT	25 mm high temperature standalone shutter
HF204HT	35 mm high temperature standalone shutter
HF110A	Filter wheel, 10 position, 25 mm diameter filters without stand
HF106A	Filter wheel, 6 position, 25 mm diameter filters without stand
HF108A	Filter wheel, 8 position, 32 mm diameter filters without stand
HF110A + HF200HT	10 position 25 mm diameter filter wheel plus shutter combination
HF108A + HF201HT	8 position 32 mm diameter filter wheel plus shutter combination

Nikon Ci configuration chart

See the following pages for more product information.

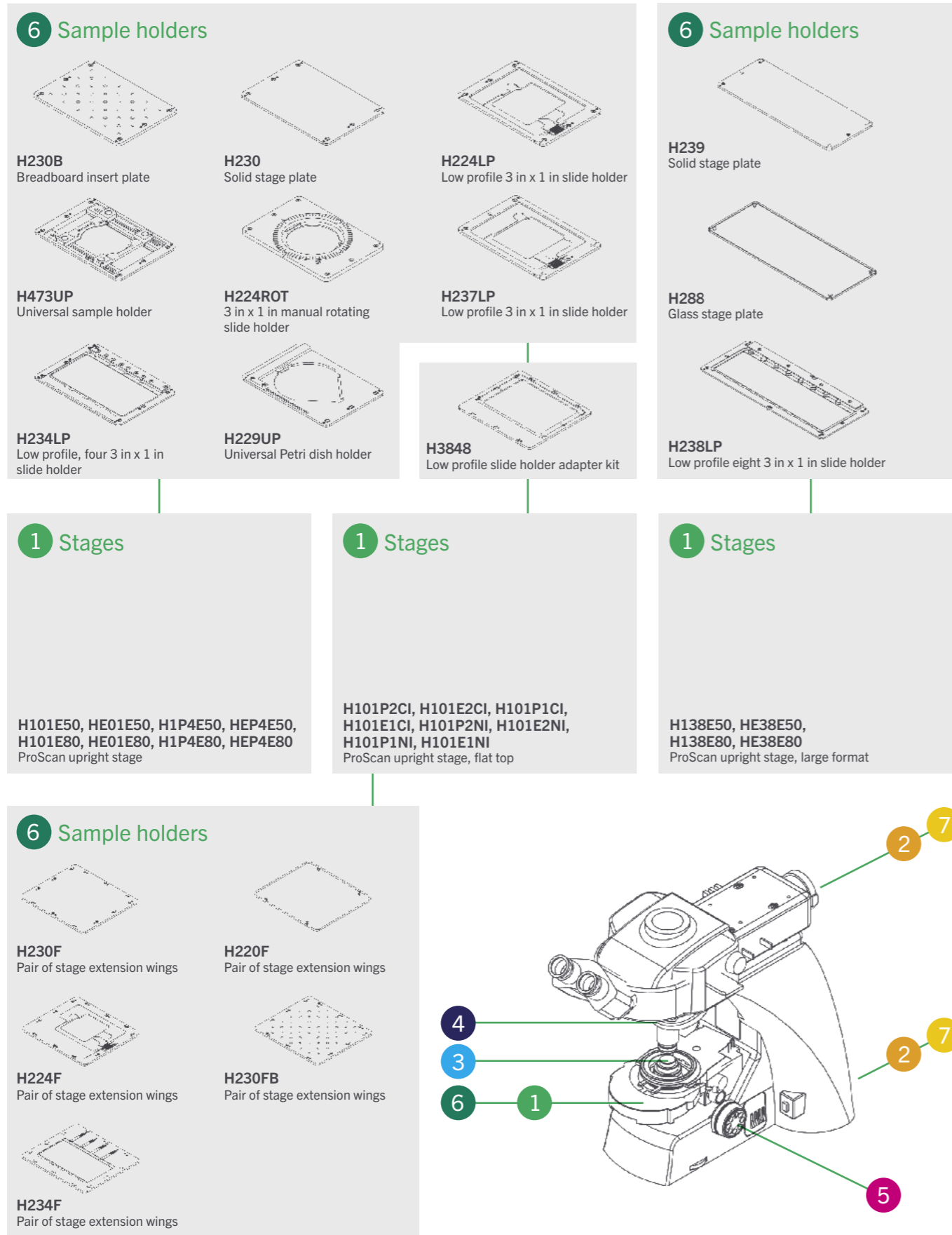

Contact Prior Scientific about robotic slide loading solutions.

Nikon Ci configuration guide

The Nikon Ci is an upright microscope with three variants; Ci-E (motorized), Ci-L (manual, LED illumination), and Ci-U (manual, halogen illumination). Prior Scientific offers an extensive range of upgrades for this microscope.

Motorized XY stages and sample holders

Stages with the suffix –E50 and –CI are compatible with all Ci models when fitted with a Nikon SS substage. Please contact Prior if you have a Ci fitted with an SSR substage. All the sample holders listed in the first section of the above table are compatible with the H101E50, HE01E50, H1P4E50, and HEP4E50. All the sample holders listed in the second section are compatible with the flat top H101P2CI, H101E2CI, H101P1CI, and H101E1CI. In addition, sample holders from the first section are compatible with the flat top stage range when combined with the H3848. The large-format H138E50 and HE38BE50 can support up to 8 slides.

Part	Description
H101E50	ProScan upright stage, part encoded, 2 mm pitch, 200 step, Nikon SS substage
HE01E50	ProScan upright stage, encoded, 2 mm pitch, 200 step, Nikon SS substage
H1P4E50	ProScan upright stage, part encoded, 1 mm pitch, 400 step, Nikon SS substage
HEP4E50	ProScan upright stage, encoded, 1 mm pitch, 400 step, Nikon SS substage
H101E80	ProScan upright stage, part encoded, 2 mm pitch, 200 step, Nikon SSR substage
HE01E80	ProScan upright stage, encoded, 2 mm pitch, 200 step, Nikon SSR substage
H1P4E80	ProScan upright stage, part encoded, 1 mm pitch, 400 step, Nikon SSR substage
HEP4E80	ProScan upright stage, encoded, 1 mm pitch, 400 step, Nikon SSR substage
H473UP	Universal sample holder (slides, Petri dishes, small flasks), upright
H224LP	Low profile 3 in x 1 in slide holder
H234LP	Low profile, four 3 in x 1 in slide holder
H237LP	Low profile 3 in x 2 in slide holder
H229UP	Universal Petri dish holder, upright stages, up to 90 mm diameter
H230	Solid stage plate, H101A stages
H224ROT	3 in x 1 in manual rotating slide holder
H230B	Breadboard insert plate M4 & M6 (H101)
H220	H101 glass stage plate assy

Large format XY motorized stages and sample holders

Part	Description
H138E50	ProScan upright stage, part encoded, 2 mm pitch, 200 step, for up to 8 slides, Nikon SS substage
HE38E50	ProScan upright stage, encoded, 2 mm pitch, 200 step, for up to 8 slides, Nikon SS substage
H138E80	ProScan upright stage, part encoded, 2 mm pitch, 200 step, for up to 8 slides, Nikon SSR substage
HE38E80	ProScan upright stage, encoded, 2 mm pitch, 200 step, for up to 8 slides, Nikon SSR substage
H238LP	Low profile eight 3 in x 1 in slide holder
H238PLP	Low profile eight 3 in x 1 in slide holder, part recessed
H239	Solid stage plate, H138 stages
H288	Glass stage plate, H138 stages

Flat top XY motorized stages and sample holders

Part	Description
H101P2CI	Proscan upright stage, flat top, 2 mm pitch, 200 step, Nikon SS substage
H101E2CI	Proscan upright stage, flat top, encoded, 2 mm pitch, 200 step, Nikon SS substage
H101P1CI	Proscan upright stage, flat top, 1 mm pitch, 200 step, Nikon SS substage
H101E1CI	Proscan upright stage, flat top, encoded, 1 mm pitch, 200 step, Nikon SS substage
H101P2NI	Proscan upright stage, flat top, 2 mm pitch, 200 step, Nikon SSR substage
H101E2NI	Proscan upright stage, flat top, encoded, 2 mm pitch, 200 step, Nikon SSR substage
H101P1NI	Proscan upright stage, flat top, 1 mm pitch, 200 step, Nikon SSR substage
H101E1NI	Proscan upright stage, flat top, encoded, 1 mm pitch, 200 step, Nikon SSR substage
H3848	Low profile slide holder adapter kit for H101F
H230F	Solid stage plate, H101F stages
H224F	Low profile 3 in x 1 in slide holder, extended, H101F stages
H234F	Four 3 in x 1 in slide holder, H101F stages
H220F	Glass stage plate, H101F stages
H230FB	Breadboard stage insert assembly (H101F)

Objective positioners and adaptors

When ordering, ensure the correct part number is used to specify inverted calibration. Objective positioners require a threaded adapter in order to be fitted to the microscope nosepiece and the microscope objective. Nikon microscopes typically use RMS threads; please contact Prior Scientific if the nosepiece uses an alternative thread size. Some Ci nosepieces have a raised lip surrounding the objective positions, which may clash with the objective positioner; a 15 mm spacer can be added to clear the lip. Please note that the two objective positions adjacent to the objective positioner will not be useable due to space constraints; additional positions may be unusable on smaller nosepieces. A high load calibration is available for specialist heavy objectives. Prior objective positioners can be controlled via NIS Elements by serial port connection. Alternative Prior/Queensgate® manufactured objective positioners can also be purchased exclusively from Nikon.

Part	Description
QGOP-400-UP-D1	OP400 objective scanner system incl. NPC-D-6110 controller for inverted microscopes (0 – 500 g load)
QGOP-400-UP-HL-D1	OP400 objective scanner system incl. NPC-D-6110 controller for inverted microscopes (500 – 1000 g load)
QG-OP-MIC-M25	OP microscope adapter M25 x 0.75
QG-OP-OBJ-M25	OP objective adapter M32 x 0.75 to M25 x 0.75
QG-OP-SPACE-M25	M25 x 0.75 static objective spacer to align with OP-400 objective

Motorized focus

The PS3H122R plus H3940 combination is required to drive the fine focus knob of the Ni-U microscope. The coarse focus will not be motorized. The H122KNI direct coupling can be added for more precise motorized control. The Ni-E (focusing stage type) contains an inherent motorized focus, so no Prior focus motor is required unless using the PF850 autofocus.

Part	Description
PS3H122R	Generic focus drive and adaptor with rotating cable system preventing cable twisting
H3940	Nikon Ni-U/Ni-C focus sleeve.
H122KNC	Direct fine focus coupling kit for Nikon Ci.

Autofocus

The PF850 is standalone hardware autofocus. The PF850 should be mounted between the objective and filter turret for fluorescence imaging. The PF200, PF209, and PF300 are required for setup and maintenance. The PF404 is required for use with piezo nanopositioning systems. Please note that the Ci-E inherent motorized focus cannot be used with the PF850. Additionally, the Ci-E motorized focus may cause some focus knob oscillation on the microscope when used with the PS2H122R, but this has not been shown to translate to problems when capturing images.

Part	Description
PF850	PF head, controller with digipot power supply, cables
LF320	PF850 flange set (Nikon)
PF209	PureFocus setup sample slide
PF201	PureFocus setup camera alignment target type 2, DIA 25 x 0.75
PF300	PureFocus setup camera jig
PF404	Piezo cable for PF850 15D to BNC

Illumination

The L200NI and L200SNI are recommended for fluorescence microscopy, [see datasheet for details](#). Note that the L200SNI has a built-in shutter mechanism that can be controlled via a ProScan III controller, so a standalone shutter is not required. The L220NI and L220SNI are available for customers doing fluorescence imaging in the far-red. The L200 and L220 systems can be fitted to the CI-FL episcopic attachment. The LDB103NI requires a ProScan III controller for operation and is recommended if purchasing a V31XYZEF controller. 35mm shutters and 32mm filter wheels are recommended for widefield applications.

Part	Description
L200SNI	L200 standard box, lamp, light guide, shutter and Nikon collimator
L200NI	L220 standard box, lamp, light guide and Nikon collimator
L220SNI	L220 standard box, lamp, light guide, shutter and Nikon collimator
L220NI	L220 standard box, lamp, light guide and Nikon collimator
LDB102NI	Brightfield LED, filter slider, standalone, Nikon
LDB103NI	Brightfield LED, filter slider, prior controller, Nikon

Excitation path

Filter wheels are not supplied with filters. Contact Prior Scientific if you wish to purchase a filter wheel stand that can be fixed to an optical table. For systems requiring a shutter and filter wheel, it is recommended to buy one of the combinations listed above. The HF220 adaptor is required for filter wheels and shutters in the episcopic (via the CI-FL episcopic attachment).

Part	Description
HF220	Filter wheel adaptor (Nikon)
HF202HT	25 mm high temperature standalone shutter
HF204HT	35 mm high temperature standalone shutter
HF110A	Filter wheel, 10 position, 25 mm diameter filters without stand
HF106A	Filter wheel, 6 position, 25 mm diameter filters without stand
HF108A	Filter wheel, 8 position, 32 mm diameter filters without stand
HF110A + HF200HT	10 position 25 mm diameter filter wheel plus shutter combination
HF108A + HF201HT	8 position 32 mm diameter filter wheel plus shutter combination

Nikon FN1 configuration chart

See the following pages for more product information.

6 Sample holders

 H230B Breadboard insert plate	 H230 Solid stage plate	 H224LP Low profile 3 in x 1 in slide holder
 H473UP Universal sample holder	 H224ROT 3 in x 1 in manual rotating slide holder	 H237LP Low profile 3 in x 1 in slide holder
 H234LP Low profile, four 3 in x 1 in slide holder	 H229UP Universal Petri dish holder	

1 Stages

H101NFN
ProScan upright stage

3 Objective positioner

 QG-OP-MIC-M25 Generic focus drive and adaptor	 QGOP-400-INV-D1 OP400 objective scanner system (0–500 g load)
 QG-OP-OBJ-M25 Direct fine focus coupling	 QGOP-400-INV-HL-D1 OP400 objective scanner system (500–1000 g load)

5 Motorized focus

PS3H122R
Generic focus drive and adaptor

H550
Focus sleeve

9 Nanopositioning sample holders

 QGSP302XR SP universal sample holder XR	 QGSP303XR Slide holder
 QGSP301XR SP multiwell holder XR	

7 Illumination

L200SNI, L220SNI
Fluorescence illuminator, built in shutter

L200NI, L220NI
Fluorescence illuminator

LDB102NI
Brightfield LED, filter slider, standalone

LDB103NI
Brightfield LED, filter slider, Prior controller

2 Excitation path

HF106A Filter wheel, 6 position, 25 mm diameter filters	HF108A + HF201HT 8 position 32 mm diameter filter wheel plus shutter combination
HF108A Filter wheel, 8 position, 32 mm diameter filters	HF110A + HF202HT 10 position 25 mm diameter filter wheel plus shutter combination
HF110A Filter wheel, 10 position, 25 mm diameter filters	 HF220 Filter wheel adaptor (Nikon)
HF202HT 25mm high temperature standalone shutter	
HF204HT 35mm high temperature standalone shutter	

6 Sample holders

 H230B Breadboard insert plate	 H230 Solid stage plate	 H224LP Low profile 3 in x 1 in slide holder
 H473UP Universal sample holder	 H224ROT 3 in x 1 in manual rotating slide holder	 H237LP Low profile 3 in x 1 in slide holder
 H229UP Universal Petri dish holder	 H234LP Low profile, four 3 in x 1 in slide holder	

1 Stages

ZDN12MP, ZDN12ME, ZDN12MK, ZDN12MF
ZDeck stages

9 Nanopositioning stages

QGSP400-D1
QGSP600-D1
QGSP800-D1

Nikon FN1 configuration guide

The Nikon FN1 is a manual microscope designed for electrophysiology. Prior Scientific can motorize many aspects of this microscope.

Motorized XY stages and sample holders

All the sample holders listed in the first section of the above table are compatible with the H101NFN, which includes an adapter plate specific to the FN1 microscope. All the sample holders listed in the second section are compatible with the ZDN12MP, ZDN12ME, ZDN12MK, and ZDN12MF. The Zdeck systems are supplied with a V31XYZE controller and PS3J100 joystick (-MK and -MF variant is not motorized, so no controller or joystick are supplied), an adaptor for the sample holders, an H473 universal sample holder, and a Nikon 108 mm ring insert.

Part	Description
H101NFN	H101A stage, Nikon FN1
H473UP	Universal sample holder (slides, Petri dishes, small flasks), upright
H224LP	Low profile 3 in x 1 in slide holder
H234LP	Low profile, four 3 in x 1 in slide holder
H237LP	Low profile 3 in x 2 in slide holder
H229UP	Universal Petri dish holder, upright stages, up to 90 mm diameter
H230	Solid stage plate, H101A stages
H224ROT	3 in x 1 in manual rotating slide holder
H230B	Breadboard insert plate M4 & M6 (H101)
H220	H101 glass stage plate assy

Zdeck stages and sample holders

Part	Description
ZDN12MP	Zdeck, Nikon, 2 mm pitch, 200 step, motorized
ZDN12ME	Zdeck, Nikon, 2 mm pitch, 200 step, motorized, encoded
ZDN12MK	Manual Zdeck, Nikon
ZDN12MF	Zdeck, Nikon, fixed
H224LP	Low profile 3 in x 1 in slide holder
H234LP	Low profile, four 3 in x 1 in slide holder
H237LP	Low profile 3 in x 2 in slide holder
H229UP	Universal Petri dish holder, upright stages, up to 90 mm diameter
H230	Solid stage plate, H101A stages
H224ROT	3 in x 1 in manual rotating slide holder
H230B	Breadboard insert plate M4 & M6 (H101)
H220	H101 glass stage plate assy

Nanopositioning stages and sample holders

Nanopositioning stages require a suitable motorized stage for mounting. All Prior motorized stages listed in this guide are compatible. Please get in touch with Prior Scientific if the microscope has another brand of the motorized stage. Note that a sample holder from the nanopositioning stage section is required for use and replaces the sample holder fitted to the motorized stage. Please discuss the use of a nanopositioning stage with Prior Scientific when placing your order if using a rotary nosepiece.

Part	Description
QGSP400-D1	System SP400, 400 µm travel, and NPC-D-6110 controller
QGSP600-D1	System SP600, 600 µm travel, and NPC-D-6110 controller
QGSP800-D1	System SP800, 800 µm travel, and NPC-D-6110 controller
QGSP301XR	SP multiwell holder XR
QGSP302XR	SP universal sample holder XR
QGSP303XR	SP single slide holder suitable for 1 in x3 in and 2 in x3 in slides

Objective positioners

When ordering, ensure the correct part number is used to specify inverted calibration. Objective positioners require a threaded adapter to be fitted to the microscope nosepiece and the microscope objective. Nikon microscopes typically use RMS threads; please contact Prior Scientific if the nosepiece uses an alternative thread size. Some FN1 nosepieces have a raised lip surrounding the objective positions, which may clash with the objective positioner; a 15 mm spacer can be added to clear the lip. Please specify the nosepiece attachment fitted to the microscope when ordering. Please note that the two objective positions adjacent to the objective positioner will not be useable due to space constraints; additional positions may be unusable on smaller nosepieces. A high load calibration is available for specialist heavy objectives. Control of the via Nikon Software requires using the Nikon Realtime Controller.

Part	Description
QGOP-400-UP-D1	OP400 objective scanner system incl. NPC-D-6110 controller for inverted microscopes (0 – 500 g load)
QGOP-400-UP-HL-D1	OP400 objective scanner system incl. NPC-D-6110 controller for inverted microscopes (500 – 1000 g load)
QG-OP-MIC-M25	OP microscope adapter M25 x 0.75
QG-OP-OBJ-M25	OP objective adapter M32 x 0.75 to M25 x 0.75
QG-OP-SPACE-M25	M25 x 0.75 static objective spacer to align with OP-400 objective

Motorized focus

The PS3H122R plus H550 combination is required to drive the fine focus knob of the microscope. The coarse focus will not be motorized. Prior Scientific offers a specific kit (NIKFN1EK) for mounting an encoder probe (H393) into the microscope if the encoding is required. Enquire with the regional Prior Scientific office for the best way to purchase this configuration.

Part	Description
PS3H122R	Generic focus drive and adaptor with rotating cable system preventing cable twisting
H550	Focus adaptor (Prior/Swift)

Illumination

The L200NI and L200SNI are recommended for fluorescence microscopy, [see datasheet for details](#). Note that the L200SNI has a built-in shutter mechanism that can be controlled via a ProScan III controller, so a standalone shutter is not required. The L220NI and L220SNI are available for customers doing fluorescence imaging in the far-red. The LDB103NI requires a ProScan III controller for operation and is recommended if purchasing a V31XYZEF controller. 35 mm shutters and 32 mm filter wheels are recommended for widefield applications.

Part	Description
L200SNI	L200 standard box, lamp, light guide, shutter and Nikon collimator
L200NI	L220 standard box, lamp, light guide and Nikon collimator
L220SNI	L220 standard box, lamp, light guide, shutter and Nikon collimator
L220NI	L220 standard box, lamp, light guide and Nikon collimator
LDB102NI	Brightfield LED, filter slider, standalone, Nikon
LDB103NI	Brightfield LED, filter slider, prior controller, Nikon

Excitation path

Filter wheels are not supplied with filters. Contact Prior Scientific if you wish to purchase a filter wheel stand that can be fixed to an optical table. For systems requiring a shutter and filter wheel, it is recommended to buy one of the combinations listed above. The HF220 adaptor is required for filter wheels and shutters in the episcopic illumination pathway. Shutters and filter wheels cannot be added to the diascopic illumination pathway. .

Part	Description
F220	Filter wheel adaptor (Nikon)
HF202HT	25 mm high temperature standalone shutter
HF204HT	35 mm high temperature standalone shutter
HF110A	Filter wheel, 10 position, 25 mm diameter filters without stand
HF106A	Filter wheel, 6 position, 25 mm diameter filters without stand
HF108A	Filter wheel, 8 position, 32 mm diameter filters without stand
HF110A + HF200HT	10 position 25 mm diameter filter wheel plus shutter combination
HF108A + HF201HT	8 position 32 mm diameter filter wheel plus shutter combination

Nikon Ni (focusing nosepiece) configuration chart

See the following pages for more product information.

6 Sample holders

H230B Breadboard insert plate	H230 Solid stage plate	H224LP Low profile 3 in x 1 in slide holder
H473UP Universal sample holder	H224ROT 3 in x 1 in manual rotating slide holder	H237LP Low profile 3 in x 1 in slide holder
H234LP Low profile, four 3 in x 1 in slide holder	H229UP Universal Petri dish holder	

1 Stages

H101-type
See further details in the configuration guide

6 Sample holders

H230B Breadboard insert plate	H230 Solid stage plate	H224LP Low profile 3 in x 1 in slide holder
H473UP Universal sample holder	H224ROT 3 in x 1 in manual rotating slide holder	H237LP Low profile 3 in x 1 in slide holder
H229UP Universal Petri dish holder	H234LP Low profile, four 3 in x 1 in slide holder	

1 Stages

ZDN12MP, ZDN12ME, ZDN12MK, ZDN12MF
ZDeck stages

3 Objective positioner

QG-OP-MIC-M25
Generic focus drive and adaptor

QG-OP-OBJ-M25
Direct fine focus coupling

QGOP-400-INV-D1
OP400 objective scanner system (0–500 g load)

QGOP-400-INV-HL-D1
OP400 objective scanner system (500–1000 g load)

4 Autofocus

PF850
PF head, controller with digipot power supply

LF320
PF850 flange set

5 Motorized focus

PS3H122R
Generic focus drive and adaptor

H3904
Focus sleeve

9 Nanopositioning sample holders

QGSP302XR
SP universal sample holder XR

QGSP303XR
Slide holder

QGSP301XR
SP multiwell holder XR

9 Nanopositioning stages

QGSP400-D1, QGSP600-D1, QGSP800-D1

7 Illumination

L200SNI, L220SNI
Fluorescence illuminator, built in shutter

L200NI, L220NI
Fluorescence illuminator

2 Excitation path

HF106A
Filter wheel, 6 position, 25 mm diameter filters

HF108A
Filter wheel, 8 position, 32 mm diameter filters

HF110A
Filter wheel, 10 position, 25 mm diameter filters

HF108A + HF201HT
8 position 32 mm diameter filter wheel plus shutter combination

HF110A + HF202HT
10 position 25 mm diameter filter wheel plus shutter combination

HF202HT
25mm high temperature standalone shutter

HF204HT
35mm high temperature standalone shutter

HF220
Filter wheel adaptor (Nikon)

Nikon Ni (focusing nosepiece) configuration guide

The Nikon FN1 is a manual microscope designed for electrophysiology. Prior Scientific can motorize many aspects of this microscope.

Motorized XY stages and sample holders

All the sample holders listed in the first section of the above table are compatible with the H101NFN, which includes an adapter plate specific to the FN1 microscope. All the sample holders listed in the second section are compatible with the ZDN12MP, ZDN12ME, ZDN12MK, and ZDN12MF. The Zdeck systems are supplied with a V31XYZ controller and PS3J100 joystick (-MK and -MF variants are not motorized, so no controller or joystick are supplied), an adaptor for the sample holders, an H473 universal sample holder, and a Nikon 108 mm ring insert.

Part	Description
H101NFN	H101A stage, Nikon FN1
H473UP	Universal sample holder (slides, Petri dishes, small flasks), upright
H224LP	Low profile 3 in x 1 in slide holder
H234LP	Low profile, four 3 in x 1 in slide holder
H237LP	Low profile 3 in x 2 in slide holder
H229UP	Universal Petri dish holder, upright stages, up to 90 mm diameter
H230	Solid stage plate, H101A stages
H224ROT	3 in x 1 in manual rotating slide holder
H230B	Breadboard insert plate M4 & M6 (H101)
H220	H101 glass stage plate assy

Zdeck stages and sample holders

Part	Description
ZDN12MP	Zdeck, Nikon, 2 mm pitch, 200 step, motorized
ZDN12ME	Zdeck, Nikon, 2 mm pitch, 200 step, motorized, encoded
ZDN12MK	Manual Zdeck, Nikon
ZDN12MF	Zdeck, Nikon, fixed
H224LP	Low profile 3 in x 1 in slide holder
H234LP	Low profile, four 3 in x 1 in slide holder
H237LP	Low profile 3 in x 2 in slide holder
H229UP	Universal Petri dish holder, upright stages, up to 90 mm diameter
H230	Solid stage plate, H101A stages
H224ROT	3 in x 1 in manual rotating slide holder
H230B	Breadboard insert plate M4 & M6 (H101)
H220	H101 glass stage plate assy

Nanopositioning stages and sample holders

Nanopositioning stages require a suitable motorized stage for mounting. All Prior motorized stages listed in this guide are compatible. Please get in touch with Prior Scientific if the microscope has another brand of the motorized stage. Note that a sample holder from the nanopositioning stage section is required for use and replaces the sample holder fitted to the motorized stage. Please discuss the use of a nanopositioning stage with Prior Scientific when placing your order if using a rotary nosepiece.

Part	Description
QGSP400-D1	System SP400, 400 µm travel, and NPC-D-6110 controller
QGSP600-D1	System SP600, 600 µm travel, and NPC-D-6110 controller
QGSP800-D1	System SP800, 800 µm travel, and NPC-D-6110 controller
QGSP301XR	SP multiwell holder XR
QGSP302XR	SP universal sample holder XR
QGSP303XR	SP single slide holder suitable for 1 in x 3 in and 2 in x3 in slides

Objective positioners and adaptors

When ordering, ensure the correct part number is used to specify inverted calibration. Objective positioners require a threaded adapter to be fitted to the microscope nosepiece and the microscope objective. Nikon microscopes typically use RMS threads; please contact Prior Scientific if the nosepiece uses an alternative thread size. Some FN1 nosepieces have a raised lip surrounding the objective positions, which may clash with the objective positioner; a 15 mm spacer can be added to clear the lip. Please specify the nosepiece attachment fitted to the microscope when ordering. Please note that the two objective positions adjacent to the objective positioner will not be useable due to space constraints; additional positions may be unusable on smaller nosepieces. A high load calibration is available for specialist heavy objectives. Control of the via Nikon Software requires using the Nikon Realtime Controller.

Part	Description
QGOP-400-UP-D1	OP400 objective scanner system incl. NPC-D-6110 controller for inverted microscopes (0 – 500 g load)
QGOP-400-UP-HL-D1	OP400 objective scanner system incl. NPC-D-6110 controller for inverted microscopes (500 – 1000 g load)
QG-OP-MIC-M25	OP microscope adapter M25 x 0.75
QG-OP-OBJ-M25	OP objective adapter M32 x 0.75 to M25 x 0.75
QG-OP-SPACE-M25	M25 x 0.75 static objective spacer to align with OP-400 objective

Motorized focus

The PS3H122R plus H550 combination is required to drive the fine focus knob of the microscope. The coarse focus will not be motorized. Prior Scientific offers a specific kit (NIKFN1EK) for mounting an encoder probe (H393) into the microscope if encoding is required. Enquire with your regional Prior Scientific office for the best way to purchase this configuration.

Part	Description
PS3H122R	Generic focus drive and adaptor with rotating cable system preventing cable twisting
H3904	Focus adaptor

Illumination

The L200NI and L200SNI are recommended for fluorescence microscopy, [see datasheet for details](#). Note that the L200SNI has a built-in shutter mechanism that can be controlled via a ProScan III controller, so a standalone shutter is not required. The L220NI and L220SNI are available for customers doing fluorescence imaging in the far-red. The L200 and L220 systems can be fitted to the CI-FL episcopic attachment. The LDB103NI requires a ProScan III controller for operation and is recommended if purchasing a V31XYZEF controller. 35 mm shutters and 32 mm filter wheels are recommended for widefield applications.

Part	Description
L200SNI	L200 standard box, lamp, light guide, shutter and Nikon collimator
L200NI	L220 standard box, lamp, light guide and Nikon collimator
L220SNI	L220 standard box, lamp, light guide, shutter and Nikon collimator
L220NI	L220 standard box, lamp, light guide and Nikon collimator
LDB102NI	Brightfield LED, filter slider, standalone, Nikon
LDB103NI	Brightfield LED, filter slider, prior controller, Nikon

Excitation path

Filter wheels are not supplied with filters. Contact Prior Scientific if you wish to purchase a filter wheel stand that can be fixed to an optical table. For systems requiring a shutter and filter wheel, it is recommended to buy one of the combinations listed above. The HF220 adaptor is required for filter wheels and shutters in the episcopic illumination pathway. Shutters and filter wheels cannot be added to the diascopic illumination pathway. .

Part	Description
HF220	Filter wheel adaptor (Nikon)
HF202HT	25 mm high temperature standalone shutter
HF204HT	35 mm high temperature standalone shutter
HF110A	Filter wheel, 10 position, 25 mm diameter filters without stand
HF106A	Filter wheel, 6 position, 25 mm diameter filters without stand
HF108A	Filter wheel, 8 position, 32 mm diameter filters without stand
HF110A + HF200HT	10 position 25 mm diameter filter wheel plus shutter combination
HF108A + HF201HT	8 position 32 mm diameter filter wheel plus shutter combination

Nikon LV100/LV150 configuration chart

See the following pages for more product information.

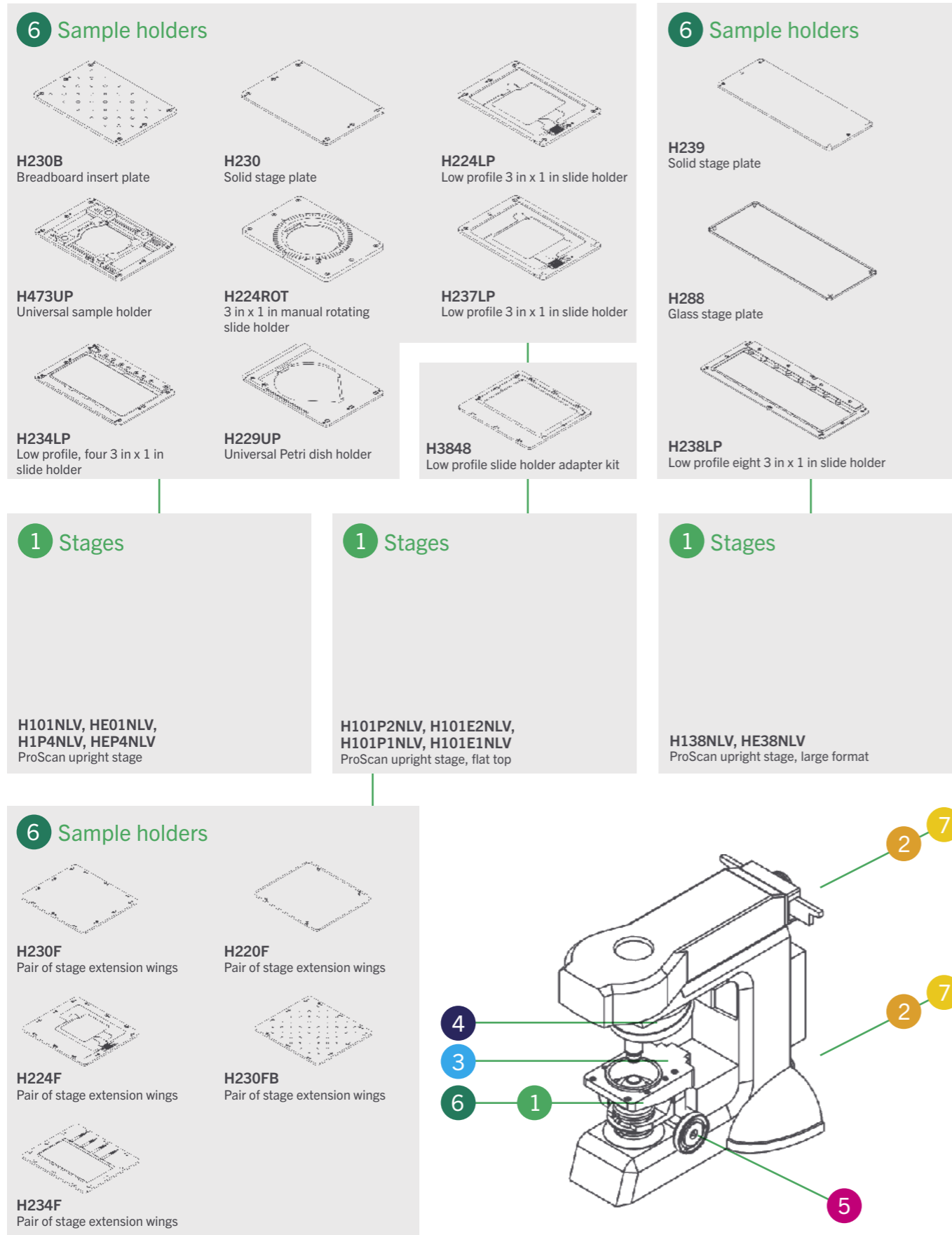

Nikon LV100/LV150 configuration guide

The Nikon LV100 and LV150 models are industrial microscopes under the LV-N product line. The LV150N, LV150NL and LV100ND are non-motorized, whereas the LV150NA and LV100NDA are motorized. Base motorization is focused on optics, and Prior Scientific can offer many motorization options for all systems.

Motorized XY stages and sample holders

A large number of stages are compatible with the LV100 and LV150 microscopes. All the sample holders listed in the first section of the above table are compatible with the H101NLV, HE01NLV, H1P4NLV, and HEP4NLV. All the sample holders listed in the second section are compatible with the flat top H101P2NLV, H101E2NLV, H101P1NLV, and H101E1NLV. In addition, sample holders from the first section are compatible with the flat top stage range when combined with the H3848. Flat top stages are recommended for ease of sample loading. The large-format H138NLV and HE38NLV can support up to 8 slides. The H105NL/2 and HE05NL/2 offer up to 6 in x 6 in travel range for semiconductor or other large sample scanning.

Part	Description
H101E50	ProScan upright stage, part encoded, 2 mm pitch, 200 step, Nikon SS substage
HE01E50	ProScan upright stage, encoded, 2 mm pitch, 200 step, Nikon SS substage
H1P4E50	ProScan upright stage, part encoded, 1 mm pitch, 400 step, Nikon SS substage
HEP4E50	ProScan upright stage, encoded, 1 mm pitch, 400 step, Nikon SS substage
H101E80	ProScan upright stage, part encoded, 2 mm pitch, 200 step, Nikon SSR substage
HE01E80	ProScan upright stage, encoded, 2 mm pitch, 200 step, Nikon SSR substage
H1P4E80	ProScan upright stage, part encoded, 1 mm pitch, 400 step, Nikon SSR substage
HEP4E80	ProScan upright stage, encoded, 1 mm pitch, 400 step, Nikon SSR substage
H473UP	Universal sample holder (slides, Petri dishes, small flasks), upright
H224LP	Low profile 3 in x 1 in slide holder
H234LP	Low profile, four 3 in x 1 in slide holder
H237LP	Low profile 3 in x 2 in slide holder
H229UP	Universal Petri dish holder, upright stages, up to 90 mm diameter
H230	Solid stage plate, H101A stages
H224ROT	3 in x 1 in manual rotating slide holder
H230B	Breadboard insert plate M4 & M6 (H101)
H220	H101 glass stage plate assy

Large Format XY motorized stages and sample holders

Part	Description
H138E50	ProScan upright stage, part encoded, 2 mm pitch, 200 step, for up to 8 slides, Nikon SS substage
HE38E50	ProScan upright stage, encoded, 2 mm pitch, 200 step, for up to 8 slides, Nikon SS substage
H138E80	ProScan upright stage, part encoded, 2 mm pitch, 200 step, for up to 8 slides, Nikon SSR substage
HE38E80	ProScan upright stage, encoded, 2 mm pitch, 200 step, for up to 8 slides, Nikon SSR substage
H238LP	Low profile eight 3 in x 1 in slide holder
H238PLP	Low profile eight 3 in x 1 in slide holder, part recessed
H239	Solid stage plate, H138 stages
H288	Glass stage plate, H138 stages

Flat top XY motorized stages and sample holders

Part	Description
H101P2CI	Proscan upright stage, flat top, 2 mm pitch, 200 step, Nikon SS substage
H101E2CI	Proscan upright stage, flat top, encoded, 2 mm pitch, 200 step, Nikon SS substage
H101P1CI	Proscan upright stage, flat top, 1 mm pitch, 200 step, Nikon SS substage
H101E1CI	Proscan upright stage, flat top, encoded, 1 mm pitch, 200 step, Nikon SS substage
H101P2NI	Proscan upright stage, flat top, 2 mm pitch, 200 step, Nikon SSR substage
H101E2NI	Proscan upright stage, flat top, encoded, 2 mm pitch, 200 step, Nikon SSR substage
H101P1NI	Proscan upright stage, flat top, 1 mm pitch, 200 step, Nikon SSR substage
H101E1NI	Proscan upright stage, flat top, encoded, 1 mm pitch, 200 step, Nikon SSR substage
H3848	Low profile slide holder adapter kit for H101F
H230F	Solid stage plate, H101F stages
H224F	Low profile 3 in x 1 in slide holder, extended, H101F stages
H234F	Four 3 in x 1 in slide holder, H101F stages
H220F	Glass stage plate, H101F stages
H230FB	Breadboard stage insert assembly (H101F)

Large format wafer scanning XY stages and sample holders

Part	Description
H105NL/2	H105NL stage, 2 mm pitch
HE05NL/2	H105NL stage, 2 mm ballscrew, encoded
H227NL	Glass stage plate, H105NL stages
H231NL	Solid stage plate, H105NL stages
HWC15SNL	Wafer chuck 4 in and 6 in wafers
HWC15VNL	Wafer chuck rot. and vac. 150 mm

Objective positioners and adaptors

When ordering, ensure the correct part number is used to specify inverted calibration. Objective positioners require a threaded adapter to fit the microscope nosepiece and the microscope objective. Nikon LV100 and LV150 microscopes use M25 or M32 threads depending on the nosepiece fitted. Some LV100 and LV150 nosepieces have a raised lip surrounding the objective positions, which may clash with the objective positioner; a 15mm spacer can be added to clear the lip. Please note that the two objective positions adjacent to the objective positioner will not be useable due to space constraints; additional positions may be unusable on smaller nosepieces. A high load calibration is available for specialist heavy objectives. Prior objective positioners can be controlled via NIS Elements by serial port connection. Alternative Prior Scientific/Queensgate® manufactured objective positioners can also be purchased exclusively from Nikon.

Part	Description
QGOP-400-UP-D1	OP400 objective scanner system incl. NPC-D-6110 controller for inverted microscopes (0 – 500 g load)
QGOP-400-UP-HL-D1	OP400 objective scanner system incl. NPC-D-6110 controller for inverted microscopes (500– 1000 g load)
QG-OP-MIC-M25	OP microscope adapter M25 x 0.75
QG-OP-MIC-M32	OP microscope adapter M32 x 0.75
QG-OP-OBJ-M25	OP objective adapter M32 x 0.75 to M25 x 0.75
QG-OP-SPACE-M25	M25 x 0.75 static objective spacer to align with OP-400 objective
QG-OP-SPACE-M25	M32 x 0.75 static objective spacer to align with OP-400 objective

Motorized focus

The PS3H122R plus H3909 combination is required to drive the fine focus knob of the LV100 and LV150 microscopes. The coarse focus will not be motorized.

Part	Description
PS3H122R	Generic focus drive and adaptor with rotating cable system preventing cable twisting
H3909	Focus adaptor (Nikon LV100)

Autofocus

The PF850 is standalone hardware autofocus. The PF850 should be mounted above the fluorescence turret in most cases. For fluorescence systems, please get in touch with Prior Scientific if the dichroics are known to block 850 nm wavelength light. The PF201, PF209, and PF300 are required for setup and maintenance. The PF404 is required for use with piezo nanopositioning systems. The PF850M is recommended for most semiconductor scanning applications. Discuss your samples with Prior Scientific before ordering.

Part	Description
PF850	PF head, controller with digipot power supply, cables
PF850M	PF head, controller with digipot power supply, cables
LF320	PF850 flange set (nikon)
PF209	PureFocus setup sample slide
PF201	PureFocus setup camera kit type 2
PF300	PureFocus setup camera jig
PF404	Piezo cable for PF850 15D to BNC

Illumination

The L200NI and L200SNI are recommended for fluorescence microscopy, [see datasheet for details](#). Note that the L200SNI has a built-in shutter mechanism that can be controlled via a ProScan III controller, so a standalone shutter is not required. The L220NI and L220SNI are available for customers doing fluorescence imaging in the far-red. The L200 and L220 systems can be fitted to compatible episcopic attachments using the LV-HGFA adapter from Nikon. The LDB103NI requires a ProScan III controller for operation and is recommended if purchasing a V31XYZEF controller. 35 mm shutters and 32 mm filter wheels are recommended for widefield applications.

Part	Description
L200SNI	L200 standard box, lamp, light guide, shutter and Nikon collimator
L200NI	L220 standard box, lamp, light guide and Nikon collimator
L220SNI	L220 standard box, lamp, light guide, shutter and Nikon collimator
L220NI	L220 standard box, lamp, light guide and Nikon collimator
LDB102NI	Brightfield LED, filter slider, standalone, Nikon
LDB103NI	Brightfield LED, filter slider, prior controller, Nikon

Excitation path

Filter wheels are not supplied with filters. Contact Prior Scientific if you wish to purchase a filter wheel stand that can be fixed to an optical table. For systems requiring a shutter and filter wheel, buying one of the combinations listed above is recommended. The HF251 adaptor is needed for filter wheels and shutters and can only be attached to the episcopic illumination port. It cannot be attached to the transmitted light port on LV100 systems.

Part	Description
HF251	Brightfield adaptor for Nikon
HF202HT	25 mm high temperature standalone shutter
HF204HT	35 mm high temperature standalone shutter
HF110A	Filter wheel, 10 position, 25 mm diameter filters without stand
HF106A	Filter wheel, 6 position, 25 mm diameter filters without stand
HF108A	Filter wheel, 8 position, 32 mm diameter filters without stand
HF110A + HF200HT	10 position 25 mm diameter filter wheel plus shutter combination
HF108A + HF201HT	8 position 32 mm diameter filter wheel plus shutter combination

Nikon L200 configuration chart

1 Stages

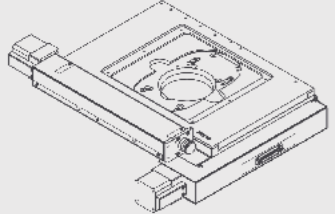

H105/2, HE05/2
ProScan stage

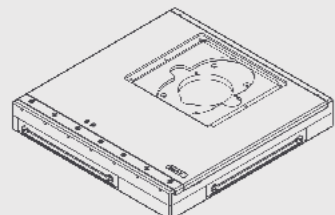

H105N2F, H105E2F
ProScan stage

6 Sample holders



H227
Glass stage plate assembly

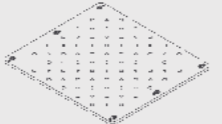

H231B
Breadboard stage insert assembly



H231
Aluminum stage plate assembly



HWC15V
Wafer chuck rot + vac 150 mm



H146
Wafer chuck, 150 mm sprung



H143
Wafer chuck spring loaded 3 in

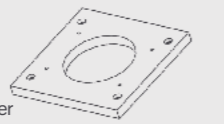

H2100
Stage spacer



HWC15S
Wafer chuck (4 in & 6 in wafers)

3 Objective positioner



QG-OP-MIC-M25
QG-OP-MIC-M32
Microscope adapter



QG-OP-Obj-M25
Objective adapter

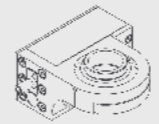

QGOP-400-INV-D1
OP400 objective scanner system
(0–500 g load)

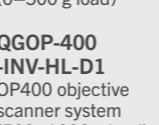

QGOP-400-INV-HL-D1
OP400 objective scanner system
(500–1000 g load)

4 Autofocus

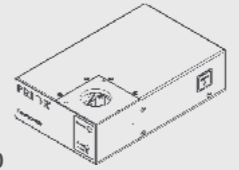

PF850
PF head, controller with digipot power supply



LF335
PF850 flange set

5 Motorized focus



PS3H122R
Generic focus drive and adaptor



H3909
Focus sleeve

1 Stages

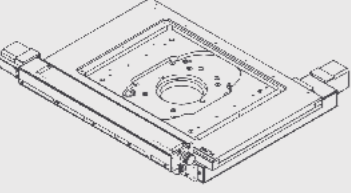

H116/2-8, HE16/2-8
ProScan stage for up to 8 inch diameter wafers

6 Sample holders

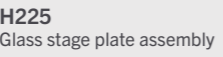

H225
Glass stage plate assembly

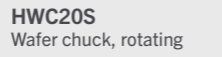

HWC20S
Wafer chuck, rotating

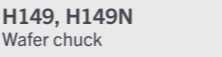

H149, H149N
Wafer chuck

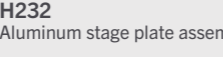

H232
Aluminum stage plate assembly

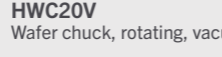

HWC20V
Wafer chuck, rotating, vacuum

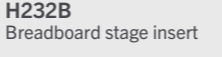

H232B
Breadboard stage insert

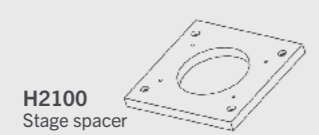

H2100
Stage spacer

7 Illumination

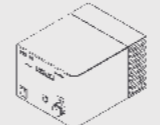

L200SNI, L220SNI
Fluorescence illuminator,
built in shutter

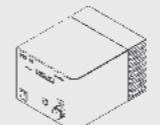

L200NI, L220NI
Fluorescence illuminator



LDB102NI
Brightfield LED, filter slider,
standalone

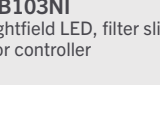

LDB103NI
Brightfield LED, filter slider,
Prior controller

2 Excitation path

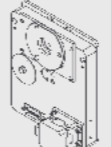

HF106A
Filter wheel, 6 position,
25 mm diameter filters

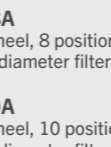

HF108A
Filter wheel, 8 position,
32 mm diameter filters



HF110A
Filter wheel, 10 position,
25 mm diameter filters



HF202HT
25mm high temperature
standalone shutter



HF204HT
35mm high temperature
standalone shutter



HF108A + HF201HT
8 position 32 mm diameter
filter wheel plus shutter
combination

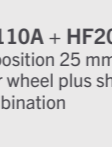

HF110A + HF202HT
10 position 25 mm diameter
filter wheel plus shutter
combination



HF251
Filter wheel adaptor (Nikon)

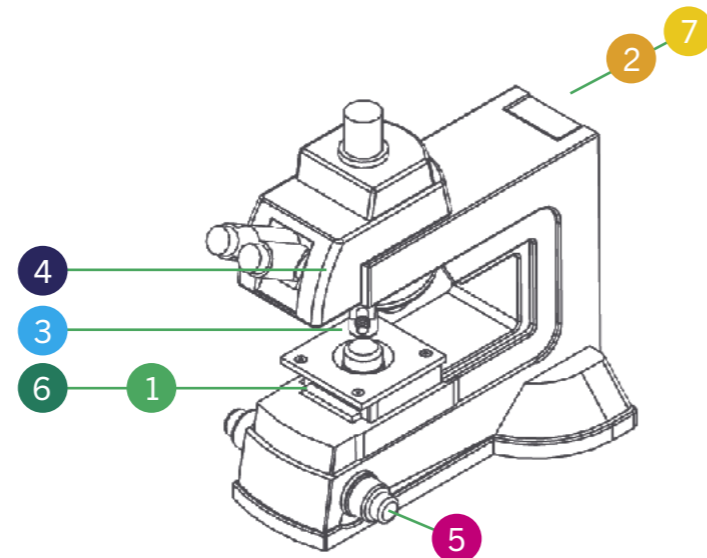

Nikon L200 configuration guide

The Nikon L200 industrial microscope is designed primarily for 8-inch wafer scanning. The L200N uses episcopic illumination, and the L200ND uses episcopic and diasopic illumination. Neither model is motorized. Prior Scientific can offer several motorization options for both systems.

Motorized XY stages and sample holders

The H116/2-8 and HE16/2-8 are the largest format stages available for the L200 systems and offer up to 10 in x 8 in on travel. Contact Prior Scientific if using a 100x objective with the HE16/2-8 as this may restrict the available travel range depending on the chosen sample holder. The H105/2NI, HE05/2NI, H105N2F, and H105E2F are also available for smaller wafers. All stages require the H2100 adapter plate. The H105N2F and H105E2F feature a flat top design for easy loading. The HWC20V and HWC15V are fitted with a vacuum nozzle, but no vacuum pump system is supplied. Other smaller stages from Prior are compatible with the L200; please get in touch with Prior Scientific to learn more. The H2100 adapter is required when using non-wafer chuck sample holders. Prior Scientific can also supply stages with dedicated vacuum shuttle systems compatible with Nikon wafer loading systems e.g., NWL200.

Part	Description
H105/2NI	ProScan stage, 154 x 154 mm travel, part encoded, 2 mm pitch, 200 step, Nikon
HE05/2NI	ProScan stage, 154 x 154 mm travel, encoded, 2mm Pitch, 200 step, Nikon
H105N2F	ProScan stage, 154 x 154 mm travel, non-encoded, 2 mm pitch, 200 step, Nikon
H105E20L	ProScan stage, 154x 154 mm travel, encoded, 2 mm pitch, 200 step, Nikon
H2100	Stage spacer (H105/116 to L200)
H227	H105 glass stage plate assembly
H231	H105 aluminium stage plate assembly
H231B	Breadboard stage insert assembly (H105)
H143	Wafer chuck spring loaded 3 in
H146	Wafer chuck, 150 mm sprung, H105 stages
HWC15S	H105 wafer chuck (4 in and 6 in wafers)
HWC15V	Wafer chuck rot + vac 150 mm/H105

Motorised XY stages and sample holders for up to 8 inch diameter wafers

Part	Description
H116/2-8	ProScan stage, 255 x 215 mm travel, part encoded, 2 mm pitch, 200 step, Nikon
HE16/2-8	ProScan stage, 255 x 215 mm travel, encoded, 2 mm pitch, 200 step, Nikon
H2100	Stage spacer (H105/116 to L200)
H225	Glass stage plate 8 in x 8 in sssembly
H232	H116 aluminium stage plate assembly
H232B	Breadboard stage insert assembly (H116)
H149	Wafer Chuck, 200 mm sprung, H116 stages
H149N	Wafer chuck, 200 mm notched sprung, H116 stages
HWC20S	Wafer chuck, rotating, 150 mm/200mm, H116 stages
HWC20V	Wafer chuck, rotating, vacuum, 200 mm, H116 stages

Objective positioners and adaptors

When ordering, ensure the correct part number is used to specify inverted calibration. Objective positioners require a threaded adapter to be fitted to the microscope nosepiece and the microscope objective. Nikon L300 microscopes use M25 or M32 threads depending on the nosepiece fitted. Some L200 nosepieces have a raised lip surrounding the objective positions, which may clash with the objective positioner; a 15 mm spacer can be added to clear the lip. Please note that the two objective positions adjacent to the objective positioner will not be useable due to space constraints; additional positions may be unusable on smaller nosepieces. A high load calibration is available for specialist heavy objectives. Prior objective positioners can be controlled via NIS Elements by serial port connection. Alternative Prior/Queensgate® manufactured objective positioners can also be purchased exclusively from Nikon.

Part	Description
QGOP-400-UP-D1	OP400 objective scanner system incl. NPC-D-6110 controller for inverted microscopes (0–500 g load)
QGOP-400-UP-HL-D1	OP400 objective scanner system incl. NPC-D-6110 controller for inverted microscopes (500–1000 g load)
QG-OP-MIC-M25	OP microscope adapter M25 x 0.75
QG-OP-MIC-M32	OP microscope adapter M32 x 0.75
QG-OP-OBJ-M25	OP objective adapter M32 x 0.75 to M25 x 0.75
QG-OP-SPACE-M25	M25 x 0.75 static objective spacer to align with OP-400 objective
QG-OP-SPACE-M25	M32 x 0.75 static objective spacer to align with OP-400 objective

Motorized focus

The PS3H122R plus H3909 combination is required to drive the fine focus knob of the L200 microscope. The coarse focus will not be motorized.

Part	Description
PS3H122R	Generic focus drive and adaptor with rotating cable system preventing cable twisting
H3909	Focus adaptor (Nikon LV100)

Autofocus

The PF850 is standalone hardware autofocus. The PF850 should be mounted above the fluorescence turret in most cases. For fluorescence systems, please contact Prior Scientific if the dichroics are known to block 850 nm wavelength light. The PF201, PF209 and PF300 are required for setup and maintenance. The PF404 is required for use with piezo nanopositioning systems. The PF850M is recommended for most semiconductor scanning applications. Discuss your samples with Prior Scientific before ordering. .

Part	Description
PF850	PF head, controller with digipot power supply, cables
PF850M	PF head, controller with digipot power supply, cables
LF320	PF850 flange set (nikon)
PF209	PureFocus setup sample slide
PF200	PureFocus Setup camera alignment target type 1, RMS.DIA 0.8 x 36
PF300	PureFocus setup camera jig
PF404	Piezo cable for PF850 15D to BNC

Illumination

The L200NI and L200SNI are recommended for fluorescence microscopy, [see datasheet for details](#). Note that The L200SNI has a built-in shutter mechanism that can be controlled via a ProScan III controller, so a standalone shutter is not required. The L220NI and L220SNI are available for customers doing fluorescence imaging in the far-red. The L200 and L220 systems can be fitted to compatible episcopic attachments using the LV-HGFA adapter from Nikon. The LDB103NI requires a ProScan III controller for operation and is recommended if purchasing a V31XYZEF controller. 35 mm shutters and 32 mm filter wheels are recommended for widefield applications.

Part	Description
L200SNI	L200 standard box, lamp, light guide, shutter and Nikon collimator
L200NI	L220 standard box, lamp, light guide and Nikon collimator
L220SNI	L220 standard box, lamp, light guide, shutter and Nikon collimator
L220NI	L220 standard box, lamp, light guide and Nikon collimator
LDB102NI	Brightfield LED, filter slider, standalone, Nikon
LDB103NI	Brightfield LED, filter slider, prior controller, Nikon

Excitation path

Filter wheels are not supplied with filters. Contact Prior Scientific if you wish to purchase a filter wheel stand fixed to an optical table. For systems requiring a shutter and filter wheel, it is recommended to buy one of the combinations listed above. The HF251 adaptor is needed for filter wheels and shutters and can only be attached to the episcopic illumination port. It cannot be attached to the transmitted light port on L200 systems.

Part	Description
HF202HT	25 mm high temperature standalone shutter
HF204HT	35 mm high temperature standalone shutter
HF110A	Filter wheel, 10 position, 25 mm diameter filters without stand
HF106A	Filter wheel, 6 position, 25 mm diameter filters without stand
HF108A	Filter wheel, 8 position, 32 mm diameter filters without stand
HF110A + HF200HT	10 position 25 mm diameter filter wheel plus shutter combination
HF108A + HF201HT	8 position 32 mm diameter filter wheel plus shutter combination

Nikon L300 configuration chart

1 Stages

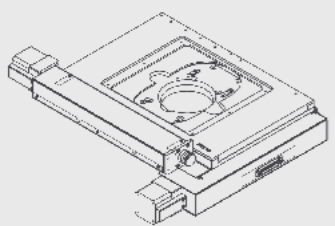

H105/2NI, HE05/2NI
ProScan stage

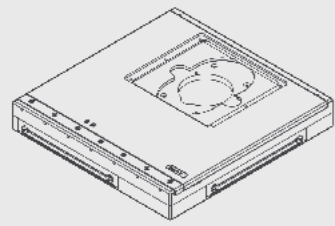

H105N2F, H105E2F
ProScan stage

6 Sample holders



H227
Glass stage plate assembly



H231B
Breadboard stage insert assembly



H231
Aluminum stage plate assembly



HWC15V
Wafer chuck rot + vac 150 mm



H146
Wafer chuck, 150 mm sprung



H143
Wafer chuck spring loaded 3 in



HWC15S
Wafer chuck (4 in & 6 in wafers)

4 Autofocus

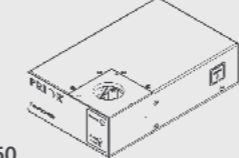

PF850
PF head, controller with digipot power supply



LF320
PF850 flange set

5 Motorized focus



PS3H122R
Generic focus drive and adaptor



H3909
Focus sleeve

3 Objective positioner



QG-OP-MIC-M25
Microscope adapter



QG-OP-MIC-M32
Microscope adapter



QG-OP-OBJ-M25
Objective adapter



QGOP-400-INV-D1
OP400 objective scanner system (0–500 g load)

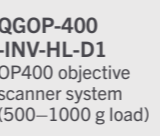

QGOP-400-INV-HL-D1
OP400 objective scanner system (500–1000 g load)

7 Illumination

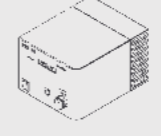

L200SNI, L220SNI
Fluorescence illuminator, built in shutter

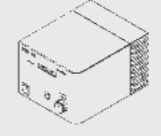

L200NI, L220NI
Fluorescence illuminator



LDB102NI
Brightfield LED, filter slider, standalone

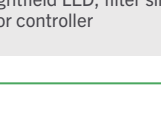

LDB103NI
Brightfield LED, filter slider, Prior controller

2 Excitation path

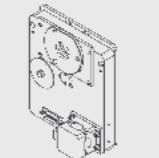

HF106A
Filter wheel, 6 position, 25 mm diameter filters

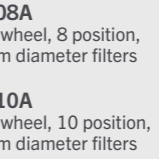

HF108A
Filter wheel, 8 position, 32 mm diameter filters



HF110A
Filter wheel, 10 position, 25 mm diameter filters

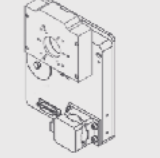

HF108A + HF201HT
8 position 32 mm diameter filter wheel plus shutter combination



HF110A + HF202HT
10 position 25 mm diameter filter wheel plus shutter combination



HF202HT
25mm high temperature standalone shutter



HF204HT
35mm high temperature standalone shutter



HF251
Filter wheel adaptor (Nikon)

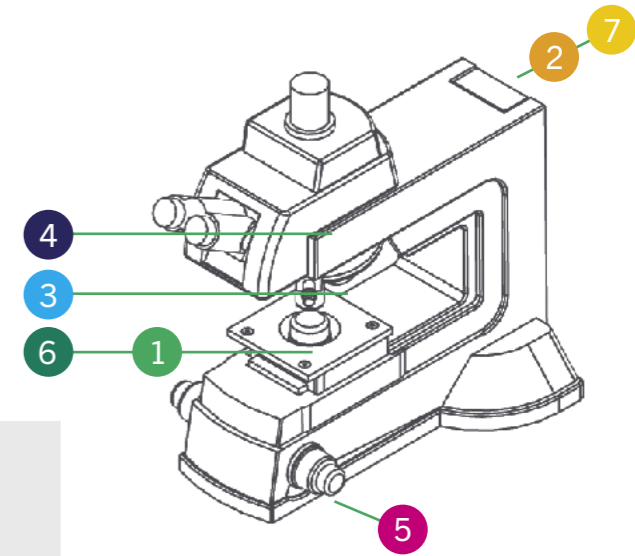

Nikon L300 configuration guide

The Nikon L300 industrial microscope is designed primarily for 12-inch wafer scanning. The L300N uses episcopic illumination, the L300ND uses episcopic and diasopic illumination, and neither model is motorized. Prior Scientific can offer several motorization options for both systems.

Motorized XY stages and sample holders

The H112/2ST and HE12/2ST are the largest stages available for L300 microscopes and can support up to 12 in x 12 in travel wafers. The H116/2-8 and HE16/2-8 are also available systems and offer up to 10 in x 8 in travel for scanning smaller wafers. Contact Prior Scientific if using a 100x objective with the HE16/2NI or HE12/2NI as this may restrict the available travel range depending on the sample holder chosen. Contact Prior Scientific if using a H112/2ST or HE12/2ST with an L300ND as the condenser from the diasopic pathway will clash with the stage. The H105/2NI, HE05/2NI, H105N2F, and H105E2F are also available for smaller wafers. When using a H105-type stage without a wafer chuck, the H2100 is required. The H105N2F and H105E2F feature a flat top design for easy loading. The HWC30V, HWC20V, and HWC15V are fitted with a vacuum nozzle, but no vacuum pump system is supplied. Other smaller stages from Prior are compatible with the L300; please get in touch with Prior Scientific to learn more. Prior Scientific can also provide stages with dedicated vacuum shuttle systems compatible with Nikon wafer loading systems e.g., NWL200.

Motorised XY stages and sample holders for up to 6 inch diameter wafers

Part	Description
H105/2NI	ProScan stage, 154 x 154 mm travel, part encoded, 2 mm pitch, 200 step, Nikon
HE05/2NI	ProScan stage, 154 x 154 mm travel, encoded, 2mm Pitch, 200 step, Nikon
H105N2F	ProScan stage, 154 x 154 mm travel, non-encoded, 2 mm pitch, 200 step, Nikon
H105E2FL	ProScan stage, 154x 154 mm travel, encoded, 2 mm pitch, 200 step, Nikon
H2100	Stage spacer (H105/116 to L200)
H227	H105 glass stage plate assembly
H231	H105 aluminium stage plate assembly
H231B	Breadboard stage insert assembly (H105)
H143	Wafer chuck spring loaded 3 in
H146	Wafer chuck, 150 mm sprung, H105 stages
HWC15S	H105 wafer chuck (4 in and 6 in wafers)
HWC15V	Wafer chuck rot + vac 150 mm/H105

Motorised XY stages and sample holders for up to 8 inch diameter wafers

Part	Description
H116/2-8	ProScan stage, 255 x 215 mm travel, part encoded, 2 mm pitch, 200 step, Nikon
HE16/2-8	ProScan stage, 255 x 215 mm travel, encoded, 2 mm pitch, 200 step, Nikon
H2100	Stage spacer (H105/116 to L200)
H225	Glass stage plate 8 in x 8 in assembly
H232	H116 aluminium stage plate assembly
H232B	Breadboard stage insert assembly (H116)
H149	Wafer Chuck, 200 mm sprung, H116 stages
H149N	Wafer chuck, 200 mm notched sprung, H116 stages
HWC20S	Wafer chuck, rotating, 150 mm/200mm, H116 stages
HWC20V	Wafer chuck, rotating, vacuum, 200 mm, H116 stages

Objective positioners and adaptors

When ordering, ensure the correct part number is used to specify inverted calibration. Objective positioners require a threaded adapter to be fitted to the microscope nosepiece and the microscope objective. Nikon L200 microscopes use M25 or M32 threads depending on the nosepiece fitted. Some L200 nosepieces have a raised lip surrounding the objective positions, which may clash with the objective positioner; a 15 mm spacer can be added to clear the lip. Please note that the two objective positions adjacent to the objective positioner will not be useable due to space constraints; additional positions may be unusable on smaller nosepieces. A high load calibration is available for specialist heavy objectives. Prior objective positioners can be controlled via NIS Elements by serial port connection. Alternative Prior Scientific/Queensgate® manufactured objective positioners can also be purchased exclusively from Nikon.

Part	Description
QGOP-400-UP-D1	OP400 objective scanner system incl. NPC-D-6110 controller for inverted microscopes (0–500 g load)
QGOP-400-UP-HL-D1	OP400 objective scanner system incl. NPC-D-6110 controller for inverted microscopes (500–1000 g load)
QG-OP-MIC-M25	OP microscope adapter M25 x 0.75
QG-OP-MIC-M32	OP microscope adapter M32 x 0.75
QG-OP-OBJ-M25	OP objective adapter M32 x 0.75 to M25 x 0.75
QG-OP-SPACE-M25	M25 x 0.75 static objective spacer to align with OP-400 objective
QG-OP-SPACE-M32	M32 x 0.75 static objective spacer to align with OP-400 objective

Motorized focus

The PS3H122R plus H3909 combination is required to drive the fine focus knob of the L300 microscope. The coarse focus will not be motorized.

Part	Description
PS3H122R	Generic focus drive and adaptor with rotating cable system preventing cable twisting
H3909	Focus adaptor (Nikon LV100)

Autofocus

The PF850 is standalone hardware autofocus. The PF850 should be mounted above the fluorescence turret in most cases. For fluorescence systems, please contact Prior Scientific if the dichroics are known to block 850nm wavelength light. The PF201, PF209 and PF300 are required for setup and maintenance. The PF404 is required for use with piezo nanopositioning systems. The PF850M is recommended for most semiconductor scanning applications. Discuss your samples with Prior Scientific before ordering.

Part	Description
PF850	PF head, controller with digipot power supply, cables
PF850M	PF head, controller with digipot power supply, cables
LF320	PF850 flange set (nikon)
PF209	PureFocus setup sample slide
PF200	PureFocus Setup camera alignment target type 1, RMS.DIA 0.8 x 36
PF300	PureFocus setup camera jig
PF404	Piezo cable for PF850 15D to BNC

Illumination

The L200NI and L200SNI are recommended for fluorescence microscopy, [see datasheet for details](#). Note that the L200SNI has a built-in shutter mechanism that can be controlled via a ProScan III controller, so a standalone shutter is not required. The L220NI and L220SNI are available for customers doing fluorescence imaging in the far-red. The L200 and L220 systems can be fitted to compatible episcopic attachments using the LV-HGFA adapter from Nikon. The LDB103NI requires a ProScan III controller for operation and is recommended if purchasing a V31XYZEF controller. 35 mm shutters and 32 mm filter wheels are recommended for widefield applications.

Part	Description
L200SNI	L200 standard box, lamp, light guide, shutter and Nikon collimator
L200NI	L220 standard box, lamp, light guide and Nikon collimator
L220SNI	L220 standard box, lamp, light guide, shutter and Nikon collimator
L220NI	L220 standard box, lamp, light guide and Nikon collimator
LDB102NI	Brightfield LED, filter slider, standalone, Nikon
LDB103NI	Brightfield LED, filter slider, prior controller, Nikon

Excitation path

Filter wheels are not supplied with filters. Contact Prior Scientific if you wish to purchase a filter wheel stand fixed to an optical table. For systems requiring a shutter and filter wheel, it is recommended to buy one of the combinations listed above. The HF251 adaptor is needed for filter wheels and shutters and can only be attached to the episcopic illumination port. It cannot be attached to the transmitted light port on L200 systems.

Part	Description
HF202HT	25 mm high temperature standalone shutter
HF204HT	35 mm high temperature standalone shutter
HF110A	Filter wheel, 10 position, 25 mm diameter filters without stand
HF106A	Filter wheel, 6 position, 25 mm diameter filters without stand
HF108A	Filter wheel, 8 position, 32 mm diameter filters without stand
HF110A + HF200HT	10 position 25 mm diameter filter wheel plus shutter combination
HF108A + HF201HT	8 position 32 mm diameter filter wheel plus shutter combination

Nikon SMZ18/25 configuration chart

See the following pages for more product information.

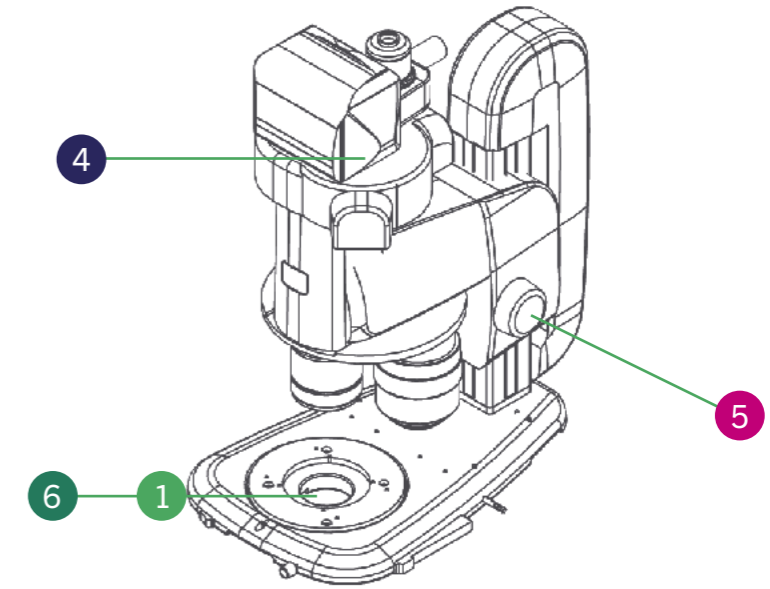
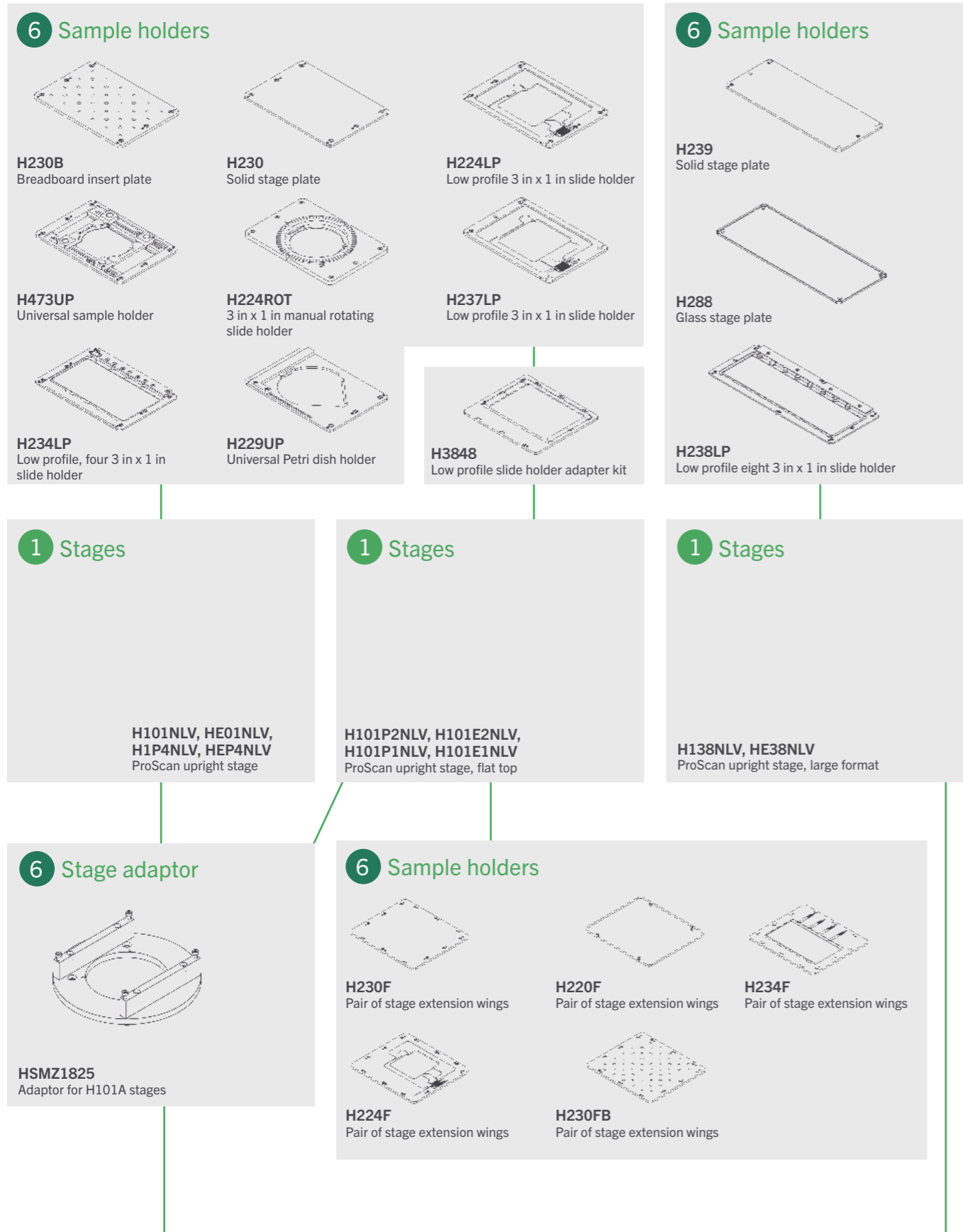

Nikon SMZ18/25 configuration guide

Prior Scientific can supply stages and, in the case of the SMZ18 and older SMZ-series systems, motorized focus upgrades for these microscopes.

Motorized XY stages and sample holders

The Nikon SMZ18 and SMZ25 are advanced stereo microscopes. The SMZ18 has a non-motorized focus, whereas the SMZ25 has an inherent motorized focus.

Part	Description
H101A	ProScan upright stage, part encoded, 2 mm pitch, 200 step
HE01A	ProScan upright stage, encoded, 2 mm pitch, 200 step
H1P4A	ProScan upright stage, part encoded, 1 mm pitch, 400 step
HEP4A	ProScan upright stage, encoded, 1 mm pitch, 400 step
H473UP	Universal sample holder (slides, Petri dishes, small flasks), upright
H224LP	Low profile 3 in x 1 in slide holder
H234LP	Low profile, four 3 in x 1 in slide holder
H237LP	Low profile 3 in x 2 in slide holder
H229UP	Universal Petri dish holder, upright stages, up to 90 mm diameter
H230	Solid stage plate, H101A stages
H224ROT	3 in x 1 in manual rotating slide holder
H230B	Breadboard insert plate M4 & M6 (H101)
H220	H101 glass stage plate assy
HSMZ1825	Adapter for mounting stages on the SMZ1825

Flat top XY motorized stages and sample holders

Part	Description
H101P2F	ProScan upright stage, flat top, part encoded, 2 mm pitch, 200 step
H101E2F	ProScan upright stage, flat top, encoded, 2 mm pitch, 200 step
H101P1F	ProScan upright stage, flat top, 1 mm pitch, 200 step
H101E1F	ProScan upright stage, flat top, encoded, 1 mm pitch, 200 step
H3848	Low profile slide holder adapter kit for H101F
H230F	Solid stage plate, H101F stages
H224F	Low profile 3 in x 1 in slide holder, extended, H101F stages
H234F	Four 3 in x 1 in slide holder, H101F stages
H220F	Glass stage plate, H101F stages
H230FB	Breadboard stage insert assembly (H101F)
HSMZ1825	Adapter for mounting stages on the SMZ1825

Large format XY motorized stages and sample holders

Part	Description
H138A	ProScan upright stage, part encoded, 2 mm pitch, 200 step, for up to 8 slides
HE38A	ProScan upright stage, encoded, 2 mm pitch, 200 step, for up to 8 slides
H238LP	Low profile eight 3 in x 1 in slide holder
H238PLP	Low profile eight 3 in x 1 in slide holder, part recessed
H239	Solid stage plate, H138 stages
H288	Glass stage plate, H138 stages
HSMZ1825	Adapter for mounting stages on the SMZ1825

Motorized focus

The PS3H122S15 must be used with the SMZ18. The SMZ25 already has motorized focus, so no add-on system is required. The PS3H122S15 can also be fitted to SMZ1270 microscopes. All non-motorized systems must be fitted with a fine and coarse focus knob. Only the fine focus knob will be motorized.

Part	Description
PS3H122S15	Generic focus drive and adaptor with rotating cable system preventing cable twisting

Nikon MA200 configuration chart

6 Sample holders

- H223XRNC**
Extra recessed for micro titre plates (85 x 128 mm)
- H234XR**
Four slide holder, extra recessed
- H658**
Holder for six mounted metallurgical specimens
- H224XRLP**
Low profile 3 in x 1 in slide holder
- H473XR**
Universal sample holder
- H659**
Holder for one mounted metallurgical specimen
- H237XRLP**
Low profile 3 in x 2 in slide holder
- H229XR**
Universal Petri dish holder
- H649**
Holder for a single mounted metallurgical specimen

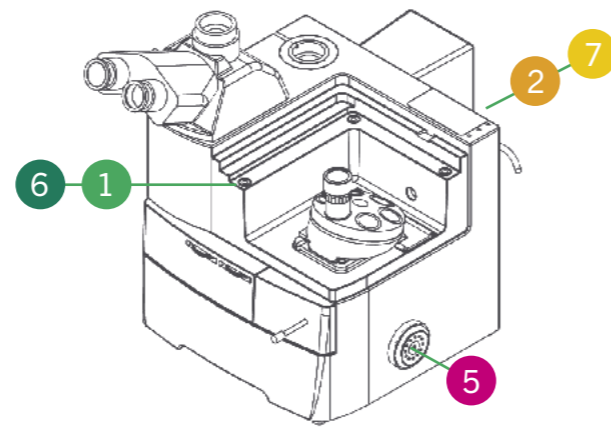

1 Stages

H117P1M4, H117E1M4
ProScan inverted stage

7 Illumination

L200SNI, L220SNI
Fluorescence illuminator, built in shutter

L200NI, L220NI
Fluorescence illuminator

2 Excitation path

HF106A
Filter wheel, 6 position, 25 mm diameter filters

HF108A
Filter wheel, 8 position, 32 mm diameter filters

HF110A
Filter wheel, 10 position, 25 mm diameter filters

HF108A + HF201HT
8 position 32 mm diameter filter wheel plus shutter combination

HF110A + HF202HT
10 position 25 mm diameter filter wheel plus shutter combination

HF202HT
25mm high temperature standalone shutter

HF204HT
35mm high temperature standalone shutter

HF251
Filter wheel adaptor (Nikon)

5 Motorized focus

PS3H122R
Generic focus drive and adaptor

H3273
Focus sleeve

Nikon MA200 configuration guide

The MA200 is an advanced inverted materials microscope. Prior can offer multiple high-end upgrades for this microscope. The MA100N is a smaller format inverted materials microscope. Prior Scientific can offer motorized focus and lower end motorized stage upgrades for this microscope,

Motorized XY stages and sample holders

All the sample holders listed are compatible with the H117P1M4 and H117E1M4. For the MA100, only an Optiscan system based around the ES107NTS stage (not shown) can be fitted to this microscope. The sample holders listed here are not compatible with this stage; contact Prior Scientific and your system will be configured with recessed (-R) rather than extra recessed (-XR) sample holders.

Part	Description
H117N1M4	ProScan inverted stage, non encoded, 1 mm pitch, 400 step, nikon ma200
H117E1M4	ProScan inverted stage, encoded, 1 mm pitch, 400 step, nikon ma200
H473XR	Universal sample holder (slides, Petri dishes, small flasks), extra recessed
H224XRLP	Low profile 3 in x 1 in slide holder, extra recessed
H229XR	Universal Petri dish holder, extra recessed
H234XR	Four 3 in x 1 in slide holder, extra recessed
H23X200	200 ml flask holder (Greiner)
H237XRLP	Low profile 3 in x 2 in slide holder, extra recessed
H229D35XR-6	Holder for 6 x 35 mm Petri dishes
H649	Holder for a single 1 in, 1.25 in and 1.5 in mounted metallurgical specimen
H657	Holder for one mounted metallurgical specimen, 2 in diameter
H658	Holder for six mounted metallurgical specimens, 1.25 in diameter
H659	Holder for one mounted metallurgical specimen, 15 in diameter with 1, 2, 4, or 8 chambers

Motorized focus

The PS3H122R plus H3273 combination is required to drive the fine focus knob of the MA200 and MA100 microscopes. The coarse focus will not be motorized.

Part	Description
PS3H122R	Generic focus drive and adaptor with rotating cable system preventing cable twisting
H3273	IX focus sleeve.

Illumination

MA200 only. The L200NI and L200SNI are recommended for fluorescence microscopy, [see datasheet for details](#). Note that The L200SNI has a built-in shutter mechanism that can be controlled via a ProScan III controller, so a standalone shutter is not required. The L220NI and L220SNI are available for customers doing fluorescence imaging in the far-red. The L200 and L220 systems can be fitted to compatible episcopic attachments using the LV-HGFA adapter from Nikon. The LDB103NI requires a ProScan III controller for operation and is recommended if purchasing a V31XYZEF controller. 35 mm shutters and 32 mm filter wheels are recommended for widefield applications.

Part	Description
L200SNI	L200 standard box, lamp, light guide, shutter and Nikon collimator
L200NI	L220 standard box, lamp, light guide and Nikon collimator
L220SNI	L220 standard box, lamp, light guide, shutter and Nikon collimator
L220NI	L220 standard box, lamp, light guide and Nikon collimator
LDB102NI	Brightfield LED, filter slider, standalone, Nikon
LDB103NI	Brightfield LED, filter slider, prior controller, Nikon

Excitation path

MA200 only. Filter wheels are not supplied with filters. Contact Prior Scientific if you wish to purchase a filter wheel stand that can be fixed to an optical table. For systems requiring a shutter and filter wheel, buying one of the combinations listed above is recommended. The HF251 adaptor is needed for filter wheels and shutters and can only be attached to the episcopic illumination port. It cannot be attached to the transmitted light port on L200 systems.

Part	Description
HF202HT	25 mm high temperature standalone shutter
HF204HT	35 mm high temperature standalone shutter
HF110A	Filter wheel, 10 position, 25 mm diameter filters without stand
HF106A	Filter wheel, 6 position, 25 mm diameter filters without stand
HF108A	Filter wheel, 8 position, 32 mm diameter filters without stand
HF110A + HF200HT	10 position 25 mm diameter filter wheel plus shutter combination
HF108A + HF201HT	8 position 32 mm diameter filter wheel plus shutter combination

PRIOR[®]

Scientific

 prior.com
 [linkedin.com/company/prior-scientific](https://www.linkedin.com/company/prior-scientific)
 [@PriorScientific](https://twitter.com/PriorScientific)

UNITED KINGDOM

Prior Scientific Instruments Ltd.
Units 3-4 Fielding Industrial Estate
Wilbraham Road, Fulbourn
Cambridge, CB21 5ET
United Kingdom
Email: inquiries@prior.com
Phone: +44 (0)1223 881711

U.S.A.

Prior Scientific, Inc.
80 Reservoir Park Drive
Rockland, MA. 02370
U.S.A.
Email: info@prior.com
Phone: 781.878.8442

GERMANY

Prior Scientific Instruments GmbH
Maria-Pawlowna-Str. 4
D-07743, Jena, Germany
Email: jena@prior.com
Phone: +49 (0) 3641 24 20 10

JAPAN

Prior Scientific KK
Kayabacho 3rd Nagaoka Bldg 10F,
2-7-10, Nihonbashi Kayabacho, Chuo-Ku,
Tokyo103-0025, Japan
Email: info-japan@prior.com
Phone: 03-5652-8831

CHINA

Prior Scientific Instruments (Suzhou) Ltd.
509 Tayun Plaza, 188 Tayun Road
Suzhou, 215000, China
Email: info-china@prior.com
Phone: +86 (0)512 6617 5866



FM 61600

