



Enabling OCT with Innovative Solutions

Wasatch) Photonics

OCT below the surface

The field of optical coherence tomography began in 1990 with an expedition into the eye to better understand its structure, and it drew on the latest technology in femtosecond optics, low coherence interferometry and telecommunications to do so. Today, OCT is present in almost every ophthalmologist's practice, [saving vision](#) and improving outcomes for millions of people each year. At Wasatch Photonics, we see OCT as a transformative technology with potential well beyond the clinic, and we seek to enable those applications with innovative solutions – for the home, the plant, the surgical suite, and the field. If you have a vision for OCT, we're ready to be the power behind those possibilities and transform the world with you.

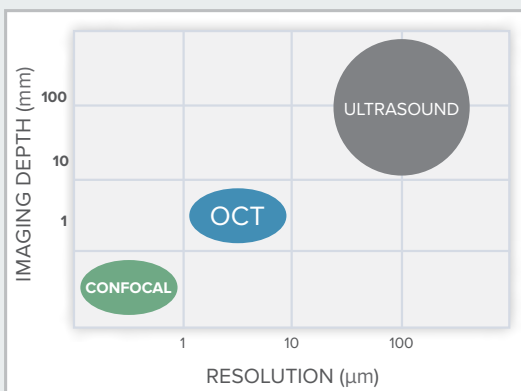
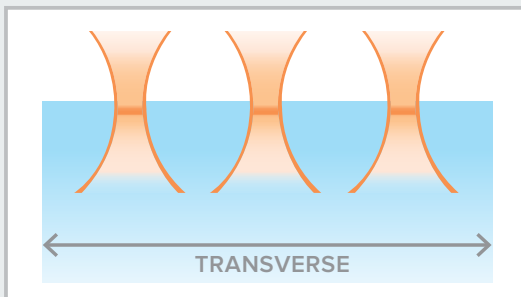
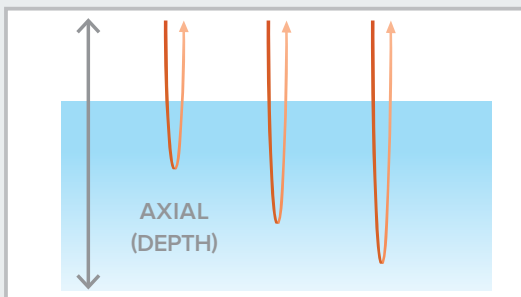

What is OCT?

[Optical Coherence Tomography \(OCT\)](#) is a non-destructive 3D imaging technique already widely deployed in ophthalmology. It is an optical analog of ultrasound that uses infrared light to probe the sample and rapidly create a 3D image from a series of cross-sections. Non-contact and non-invasive, it is equally suited to imaging of delicate samples and high-throughput manufacturing.

[Wasatch Photonics OCT systems](#) use spectral domain OCT (SD-OCT), in which the interference of many frequencies of light is recorded using a spectrometer and analyzed to generate a cross-sectional image. We offer high axial and transverse resolution at reasonable cost, at scan rates up to 250 kHz. Starting with our own [ultra-sensitive spectrometers](#), we create [OCT systems](#) with [superior depth penetration](#) and [resolution](#) for research. We also develop [custom solutions for OEM](#) and [industrial applications](#).

Why Choose OCT?

While ultrasonic inspection is considered the standard in subsurface imaging, it is limited in its speed and resolution, and requires the use of a coupling medium. Confocal imaging provides submicron resolution, but is very expensive and limited to depths of <1 mm.

OCT provides intermediate imaging depth at both high resolution and speed. It retains ultrasound's flexibility in taking the probe to the sample, yet is non-contact and compatible with small or delicate samples. Unlike confocal imaging, it can be used by a non-specialist, and integrates well with other systems for guided imaging.

Why Wasatch for OCT solutions

In the rapidly expanding world of OCT, what makes one company different than the rest? At [Wasatch Photonics](#), we offer a unique combination of vision, talent, and technology that help bridge the gap between research and reality for those seeking solutions to the problems facing our world.

Independently owned & innovation-minded, we have the freedom to pursue the projects with the potential to do the most good, and the passion and determination to see them through. We are constantly building toward the future, with expanded capacity, new talent, and better processes to sustain our momentum. And through it all, we are keeping our eye on what is important to you:

1

Powerful building blocks

We've optimized our [spectrometers](#), [probes](#), [software](#), and [systems](#) specifically for OCT, with a focus on ease of integration, customization, and use by researchers and [OEMs](#). Let us speed your development with drop-in solutions tuned to your specific application.

2

Applications expertise

Our team brings a wealth of experience in [OCT applications](#) and systems design, and an intimate understanding of our product performance and possibilities, allowing us to connect product and purpose with elegant, cost-effective solutions.

3

Better images – faster

By manufacturing our own proprietary [gratings](#) and preserving [every possible photon](#) that travels through our spectrometers, we have the sensitivity to see deeper, clearer, and collect great images faster. Leverage our expertise to minimize your time spent on design.

4

A partner you can trust

Whether you want a turnkey system for research or a drop-in module for an [OEM design](#), we are committed to providing the solution you need. As an [ISO 9001:2015 facility](#), we are focused on quality and customer service, from one to a thousand units.

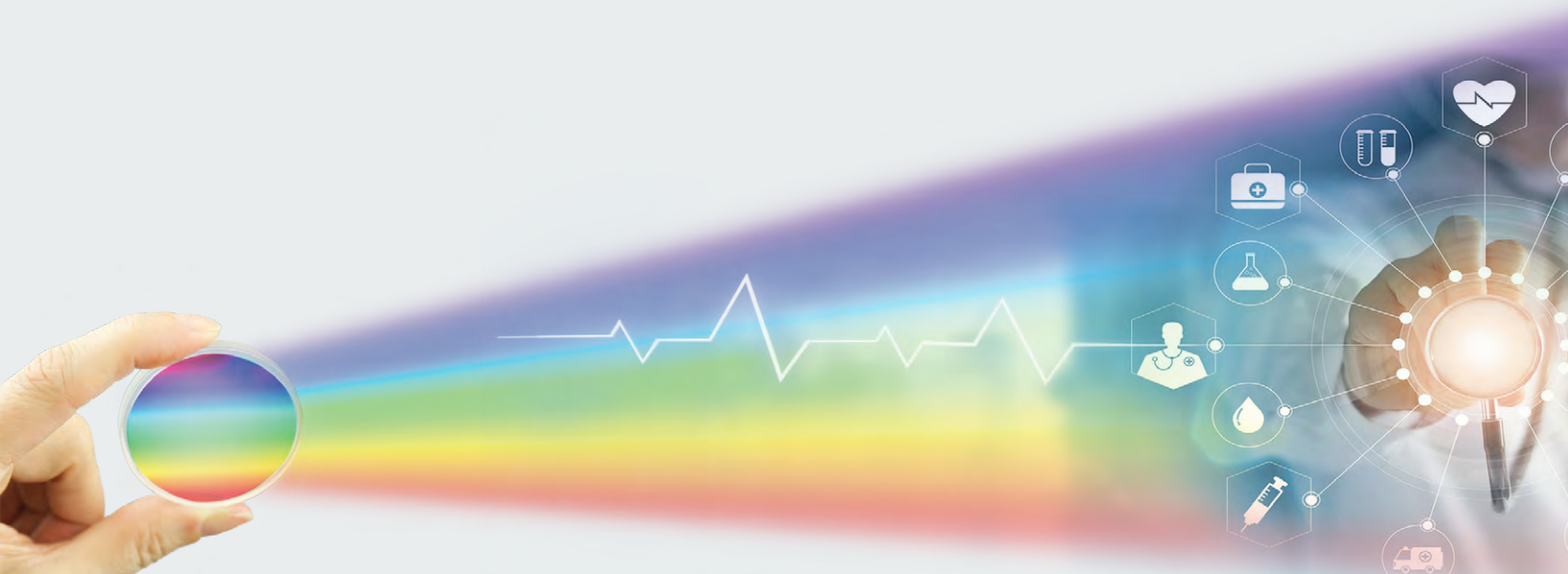

Powerful building blocks

At [Wasatch Photonics](#), we understand all aspects of system design needed to generate high quality [OCT images](#), and we've created a line of best-in class components to do so. Speed your system development and reduce risk by leveraging our drop-in components and [software solutions](#). Choose from our many options to get exactly the performance you need for your application. Turnkey ease – custom to you.

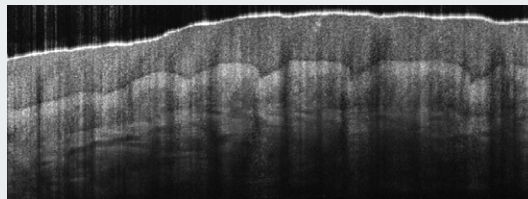
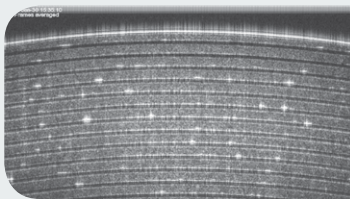
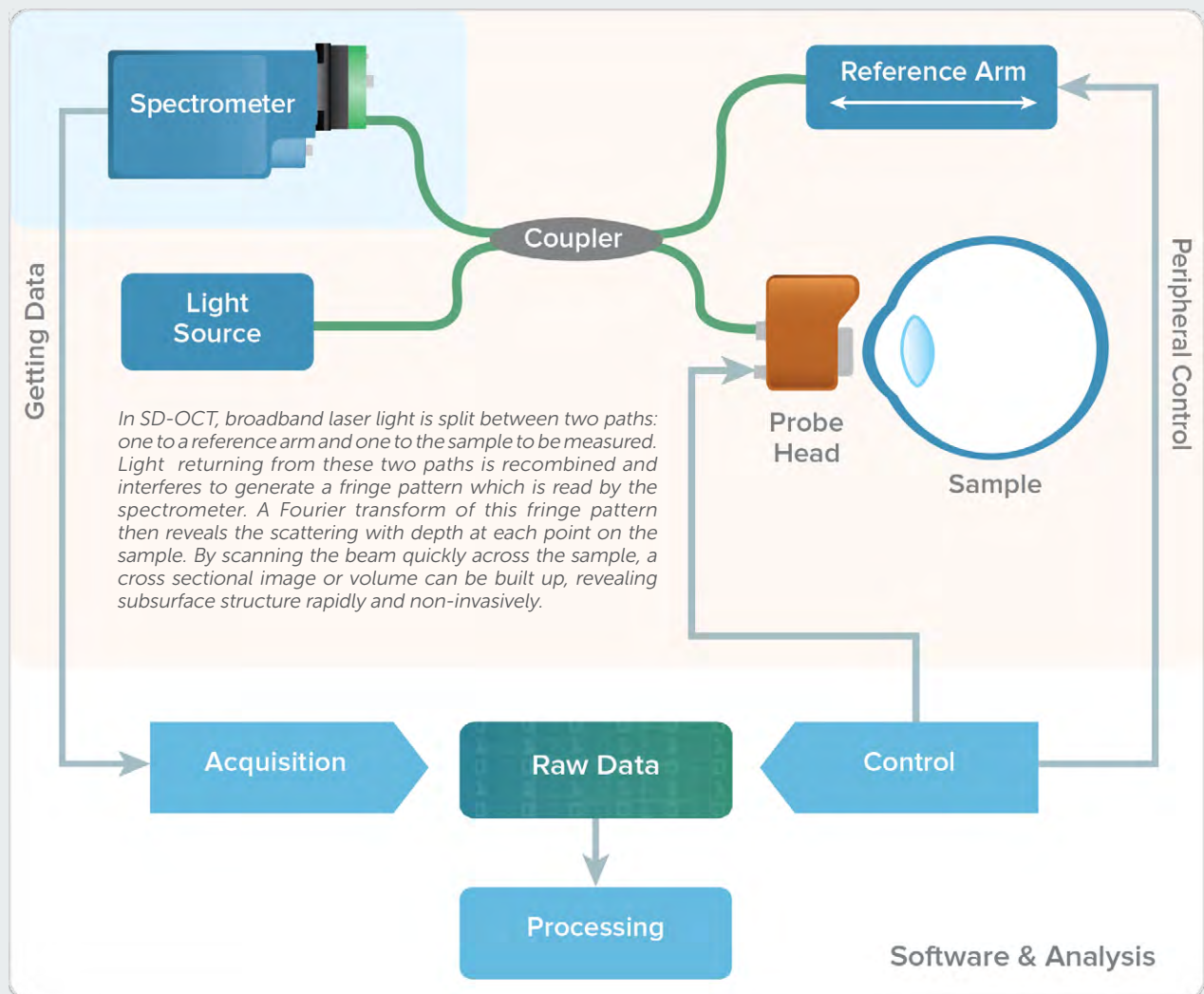

To learn more about the fundamentals of OCT, check out our online tutorial:
<https://wasatchphotonics.com/oct-tutorial/>



HIGH PERFORMANCE SPECTROMETERS

The best images start with the right spectrometer, and our [Cobra series](#) offers more than 20 models with speeds up to 250 kHz to deliver your perfect fit. Choose from [visible](#), [800](#), [1050](#), or [1300 nm](#) imaging and multiple bandwidths to get the depth and resolution you need, then select the camera, speed and connection right for your application (including USB 3.0!). All of our spectrometers are designed for best resolution and low cross-talk to achieve the best roll-off performance possible. Ask about our innovative [long-range 800 nm design](#), for depths up to 12 mm!



PROBES & ACCESSORIES

Bring OCT right to your sample with our line of [fiber-coupled sample arm probes](#), available with MEMS or galvo scanning. Our innovative optical design and robust scan electronics deliver aberration-free imaging at 800, 1050, or 1300 nm for best resolution and SNR. See exactly where you're imaging with an integrated color camera, and control & synchronize scanning easily with our compatible software drivers. Go from mounted to handheld in seconds, or choose our large animal retina probe for point and scan operation in veterinary applications.



POWERFUL SOFTWARE & SDKS

Our [software solutions](#) answer the needs of researchers and [OEMs](#) alike. Acquire images quickly and easily using our turnkey WP OCT [application software](#) for visualization and acquisition. Need a custom solution? Our [software libraries](#) allow you to begin acquiring images in just 30 minutes, customizing as needed while accelerating development time with guaranteed results. This trio of SDKs simplify image acquisition, optimize system control, and deliver powerful parallel data processing for cameras up to 250 kHz line rates.



Applications in sight and beyond

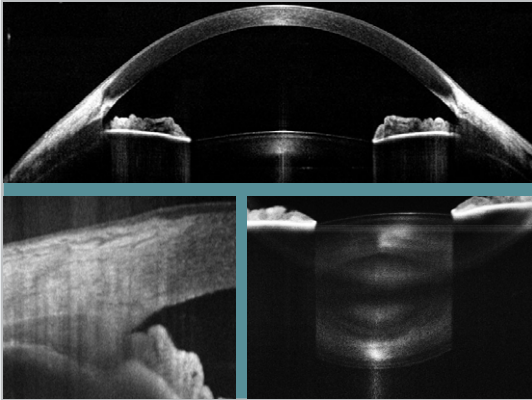

ANTERIOR SEGMENT Cornea, lens, and angles

The front of the eye is responsible for light collection and focusing. Structural or functional issues in this area result in conditions like glaucoma, cataracts, dry eye, keratoconus, and presbyopia. Our [800 nm OCT](#) offers high-resolution [imaging of the cornea](#) that can potentially be used to diagnose, monitor, and guide treatment of related conditions. [1300 nm OCT](#) is in general more suitable for looking at the [lens](#), [iridocorneal angle](#) and the [ciliary muscle](#). These parts of the anatomy are critical for treatment of glaucoma and cataracts, including intraocular lens placement.

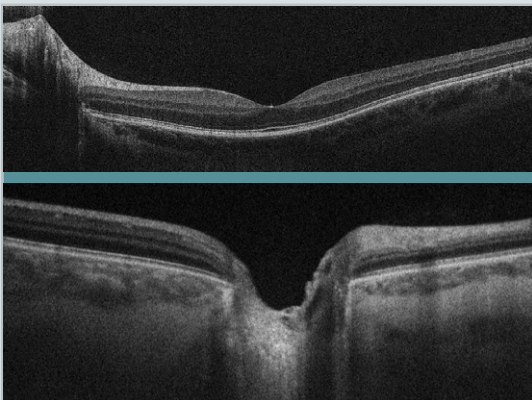

Top image courtesy of James Fujimoto, MIT

POSTERIOR SEGMENT Retina, macula, and optic nerve

The [posterior segment](#) contains the structures that perform light detection, including the [retina and optic nerve](#). Here, the high resolution and rapid scan rate of our [800 nm OCT](#) is helping to combat retinal pathologies like the progression of dry to wet AMD, including the choroidal neovascularization also relevant in diabetic retinopathy. At [1050 nm](#), we have the imaging depth needed to monitor the [nerve fiber layer](#) and optic nerve metrics to look for damage due to glaucoma or other conditions. Either wavelength can assist in assessment of macular holes and edema, providing detailed views of the [fovea](#) and all relevant retinal layers.

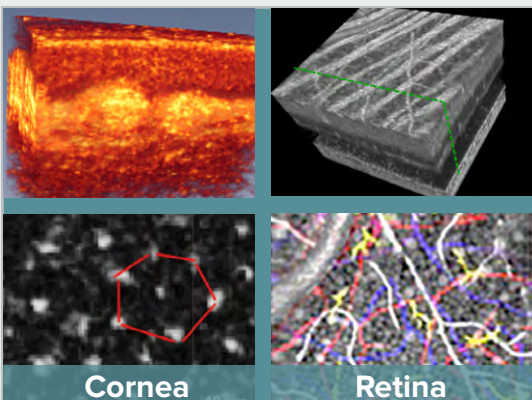

Cornea

Retina

HI-RES OPHTHALMOLOGY In-vivo Microscopic Imaging

Seeing the eye at the cellular level is essential for further advances in diagnostics and treatment, and the ultrafast speed of our [Cobra-S spectrometer](#) is enabling leading researchers to do just that. A group at the University of Waterloo has shown [in-vivo, non-contact imaging of the cornea](#) at 1.5 μm resolution with minimal motion artifacts, collecting a 3D volume in just ~ 2.8 seconds. At the retina, a joint project led by the US FDA has developed a [multimodal adaptive optics system](#) to rapidly image the full depth of the retina in 3D with stunning resolution, including the ganglion cell layer and RPE cells.

(1) Tan et al., Biomedical Optics Express 9.12 (2018): 6569-6583.
(2) Liu et al., Biomedical Optics Express 9.9 (2018): 4246-4262.

MATERIALS PROCESSING

Rapid in-situ monitoring

The demanding precision and speed required in high resolution laser micromachining and welding systems calls for [nondestructive in-situ monitoring](#) tools that are equally precise for feedback. Our OCT engines enable the speed and detailed information required to evaluate ablation rate, focus position, and depth using rapid, noncontact en face scanning for adaptive process control. They are also integrated into systems for evaluation of shapes and dimensions of tools, molds, and final parts, and for defect detection and dimensional analysis in additive manufacturing.

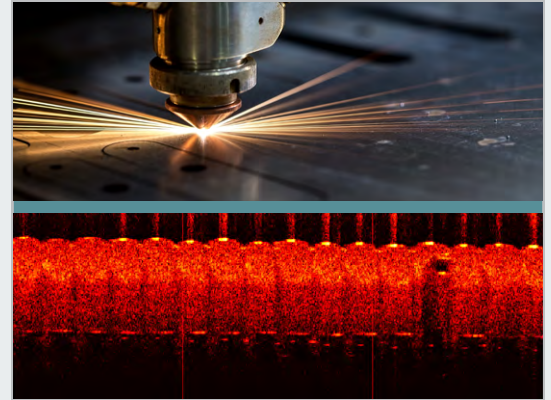

QUALITY CONTROL

Non-destructive testing

OCT's ability to provide information about subsurface structure makes it a powerful tool for [quality control](#). We've worked with manufacturers to look at the multilayered structure of coatings and paints, evaluating flatness, uniformity, and subsurface defects down to the micron level. OCT's ability to image small or delicate structures can also be used to analyze high precision medical devices, and to detect pores and defects in the production of critical membranes and seals. Many of these same qualities benefit the analysis and preservation of art and historic artifacts.

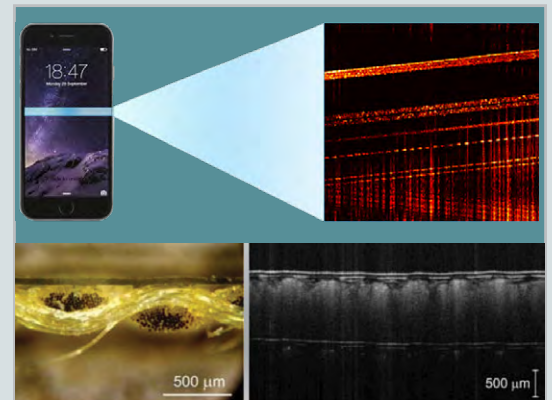

Goctawski et al., Polymers 10.5 (2018): 469.

MEDICAL

Angiography and dermatology

OCT angiography (OCT-A) allows visualization of blood flow at the microscopic level without using external contrast agents, creating a 3D profile of micro vasculature. Visible OCT takes that a step further by measuring blood oxygenation (our [Cobra VIS](#) is the only off-the-shelf!). In dermatology, we've supported researchers working to noninvasively diagnose and monitor various tissue cancers, and in assessment of tumor margins. A group at U Miami has even captured [detailed wound images](#) to rival microscopy for objective assessment of a new stem cell therapy.

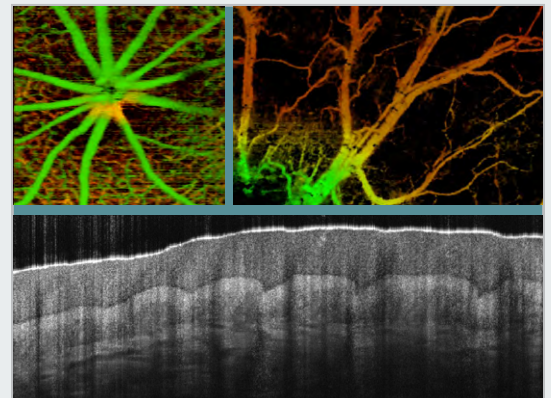

Performance that takes you further

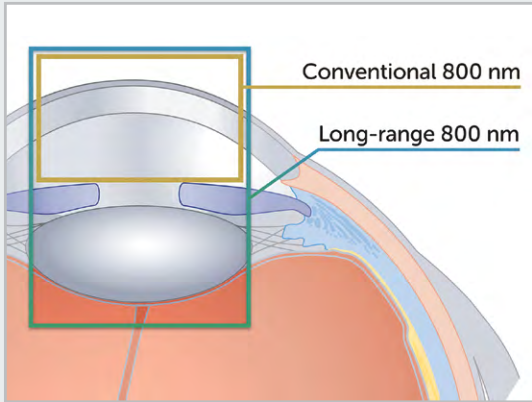

SUPERIOR SENSITIVITY & DEPTH

We've applied our expertise in spectroscopy to give our [Cobra OCT spectrometers](#) a surprising amount of resolution, performance, and value in one small box. Our compact, high-throughput designs provide exquisite detail at depths where other spectrometers struggle. In fact, our unique [long-range 800 nm](#) can image up to 12 mm to map the full anterior chamber! Our sensitivity allows you to acquire high quality images at faster rates, which translates into faster feedback for process monitoring, less motion artifacts during in-vivo imaging, and rapid mapping of 3D volumes or large areas.

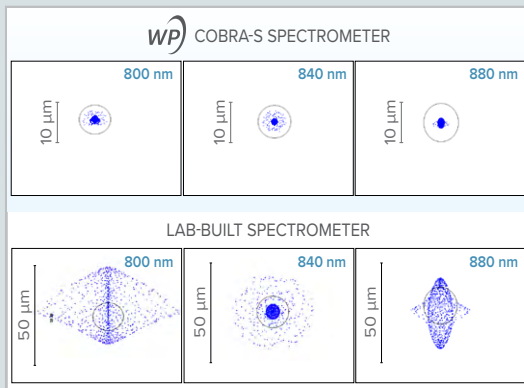

OPTIMIZED DESIGNS

OCT spectrometers require [several unique design considerations](#), which we deliver with minimal polarization dependence, low roll-off, and a compact, transmissive design for [OEM integration](#). We've developed custom optics to ensure perfect focusing onto each camera pixel, as shown in this [comparison to a lab-built spectrometer](#). Our design hits the mark at every wavelength, while the design built with off-the-shelf lenses shows bleedover into adjacent pixels. By combining our diffraction-limited optics with the lowest cross-talk cameras available, we're able to achieve better roll-off and deliver clearer images, deeper.

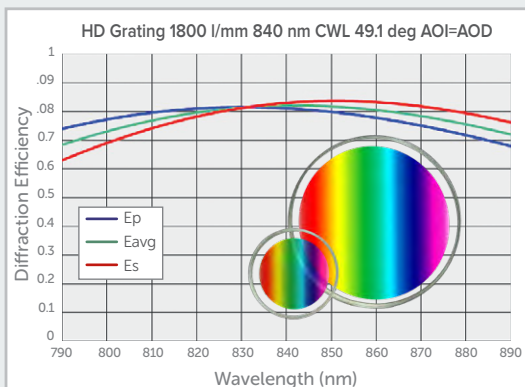

PATENTED HD GRATINGS

The clearest, deepest OCT images require an optical design that covers a broad bandwidth with maximum signal to noise. That's why we developed our [patented HD gratings](#) to have high efficiency for all polarizations, even at the extremes of a 100-200 nm operating wavelength range. Their [excellent 1st order diffraction efficiency](#) and low scatter translates into greater sensitivity and faster scan rates, and ultimately into better roll-off performance for our spectrometers. These [high-efficiency HD gratings](#) are exclusive to Wasatch Photonics, and can be customized for your [OEM design](#).

CHOICE OF WAVELENGTH

Our products include a wide variety of center wavelengths and bandwidths to achieve the best possible balance of imaging depth and resolution for your application. Choose [800 nm](#) for best resolution at lesser depths or in weakly scattering media, or [1300 nm](#) for more highly scattering samples and steep angles. [1050 nm](#) offers a compromise between the two, while [visible OCT](#) yields highest resolution and allows blood oxygenation to be analyzed simultaneously. Need both depth and resolution? Try our patent-pending [long-range 800 nm design](#) to image up to 12 mm.

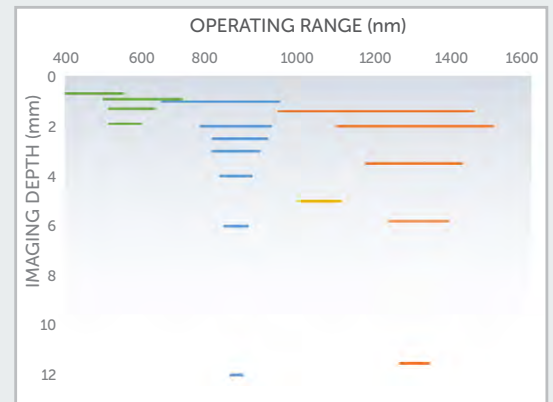

FAST, FLEXIBLE IMAGING

Choice of camera plays a large role in OCT system performance, and we've scoured the market to find the best models available. We consider factors like speed, sensitivity, noise, and especially cross talk between the camera pixels, which affects [system roll-off performance](#). We offer many of our models with multiple speed options to allow fine tuning of scan rate vs sensitivity, and can advise on the best model for your application. Our [Cobra-S](#) features the fastest camera on the market, with 250 kHz scan rates for rapid process control or 3D imaging.

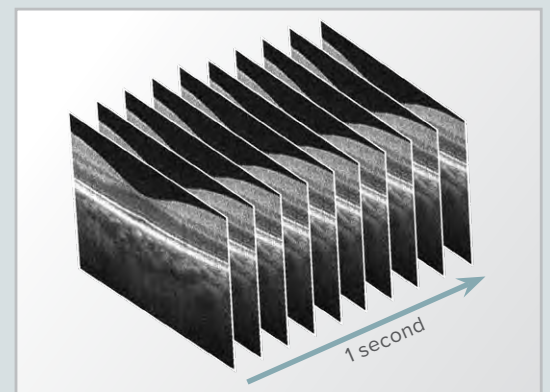

EASE OF USE

We've made it our mission to simplify the complexity of OCT imaging by providing value-add connectivity options and software to speed your system development. The [USB 3.0 interface for our Cobra-S spectrometer](#) offers speed and flexibility at reduced cost, eliminating the camera link card and allowing imaging from a laptop computer. Our flexible [software development kits](#) speed system development by providing reliable, efficient OCT-specific command calls for acquisition, precise control of our peripherals, and powerful parallel processing algorithms for maximum speed.

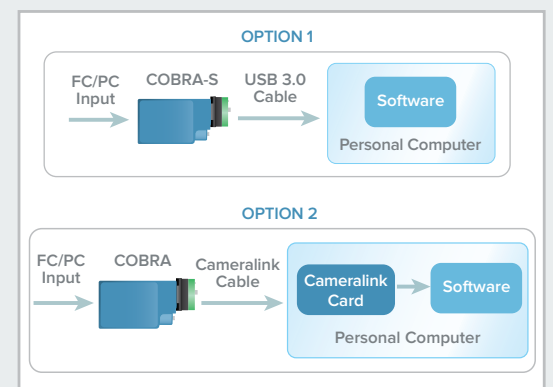

Optimized Solutions for research or industry

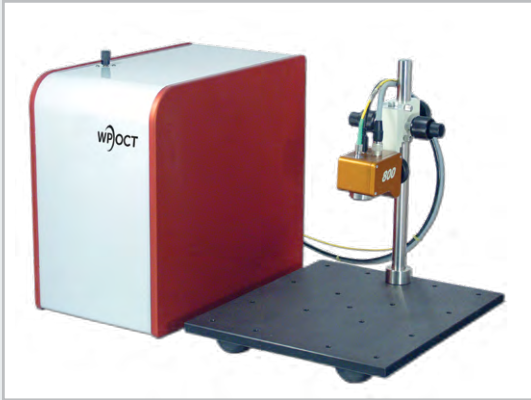

SYSTEMS FOR RESEARCH

Maximize the time spent on your research with our fully optimized, turnkey [WP OCT imaging systems](#). Designed around our best-in-class Cobra-series OCT spectrometers, these systems deliver ultra-clear imaging to greater depths than any others on the market. We've carefully refined every aspect of our system designs, from scanning synchronization and sample arm control to user-friendly software. Choose from standard models at [800](#) or [1300 nm](#) with 20-200 Hz image capture rates from 20 Hz to >200 Hz, or contact us about a custom [system](#) to leverage our experience and accelerate your research.



INTUITIVE SOFTWARE

Acquire images quickly and easily from any of our systems using [our intuitive application software](#) for visualization and acquisition. A live feed provides instant OCT imaging, while a 10 MP color camera facilitates precise selection of scan location. This software offers powerful parallel data processing algorithms, GPU-accelerated for maximum performance. Our menu options give you full control over contrast, dispersion, position, and all other imaging parameters and peripheral devices. Save images as seen on-screen or in bursts to avoid loss of useful data or capture brief events, then review or analyze later.

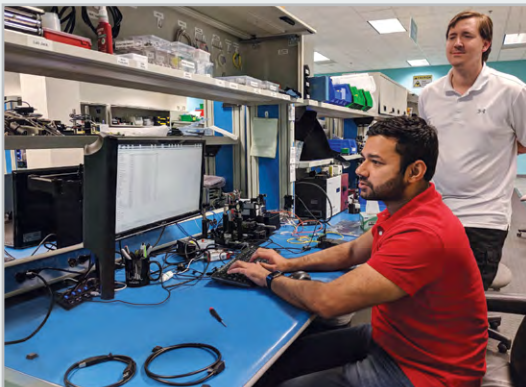

APPLICATIONS SUPPORT

We've worked daily with a wide variety of OCT applications and systems over the past decade, and our team has the experience to guide you to the best system design for your needs – including when to use standard products vs custom to optimize your timeline and outcome. Benefit from the experience we've acquired testing the many light sources, probes, and peripherals on the market to optimize your system design. Our cross-disciplinary applications knowledge gives us a unique viewpoint from which to solve new problems in innovative ways, backed by hands-on problem solving and testing.

OEM MODULES & SUBSYSTEMS

Accelerate your system design and build with a drop-in OEM module or subsystem customized to your application. Our modular products give you the flexibility to quickly test your ideas while defining requirements for your ideal solution. Our [OEMs work collaboratively with us](#) through the design and prototype stages, retaining control over the development process while conserving valuable engineering resources. Sourcing at the module level guarantees performance 'as used' vs compounding individual component tolerances. This reduces the burden on your manufacturing, and improves overall product quality.

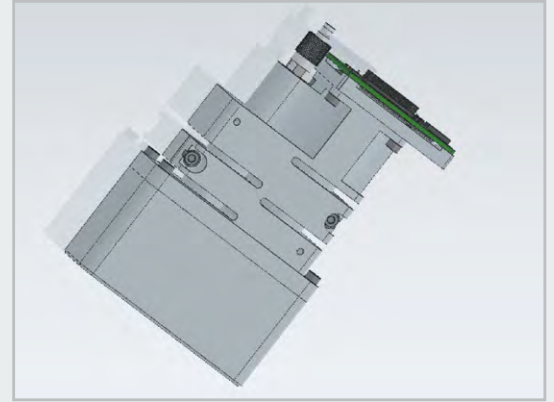

CUSTOM DESIGNS

Need something special? We often work with OEMs to adapt our spectrometer designs to new cameras, unique footprints, and custom sample types. This allows you to focus on your application, analysis, and user interface, while leaving the spectroscopy to us. We specialize in [high efficiency optics](#), and can draw on our custom in-house [VPH grating design](#) and development capabilities to create a solution unique to you. We can also develop custom front-end optics, peripherals, and sample interfaces. Let us speed your time to market with a bespoke solution that leverages our engineering strengths.

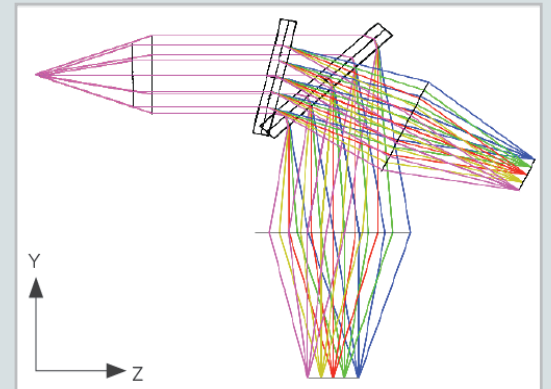

QUALITY YOU CAN TRUST

You need a partner who understands the needs of your application and your business as a whole, and we deliver with decades of experience as a team in the design and manufacture of OEM products. Our robust, drop-in solutions are designed for manufacturability to ensure uniform, dependable performance in volume. As an [ISO 9001:2015 facility](#), we are committed to quality at all levels of the organization, from controlled processes for consistent quality to hands-on management and responsive customer service. If you're ready to share your vision, we're ready to help you bring it to life.



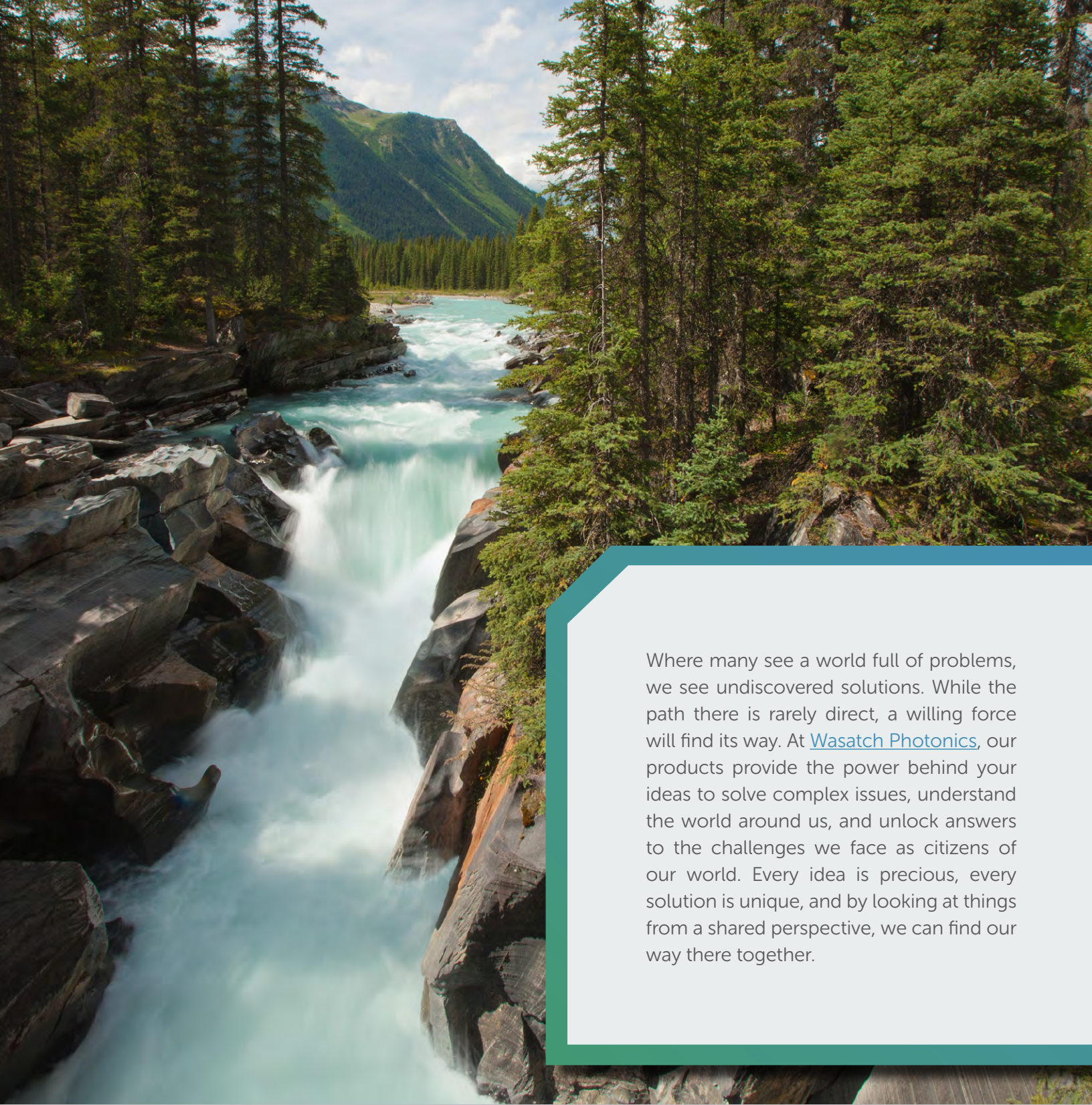

Where many see a world full of problems, we see undiscovered solutions. While the path there is rarely direct, a willing force will find its way. At [Wasatch Photonics](https://www.wasatchphotonics.com), our products provide the power behind your ideas to solve complex issues, understand the world around us, and unlock answers to the challenges we face as citizens of our world. Every idea is precious, every solution is unique, and by looking at things from a shared perspective, we can find our way there together.

Wasatch) *Photonics*

PHONE: +1 919-544-7785 | EMAIL: info@wasatchphotonics.com | [wasatchphotonics.com](https://www.wasatchphotonics.com)